

# CONSTRUCTION Catalogue

## 2021

**HYBRID** HANGER WITH  
**DIRECT** FASTENING TO **C** PROFILES or **STUD**

Ref. SE-MSN-90 A 75

Patented

# SEÑOR

# CONSTRUCTION Catalogue 2021

## HYBRID HANGER WITH DIRECT FASTENING TO C PROFILES or STUD

Ref. SE-MSN-90 A 75

### Introduction

A **DIFFERENT** and **PROFESSIONAL** hanger.  
Higher performance in the least space.  
They are **HYBRID** hangers with locking stops (**ID**)  
and a perfect installation to profiles **C** or **STUD**.

**MSN-90 A 75** is manufactured with high  
performance and renovated raw material  
providing improvements in  
the vibro-acoustic field.

### Patented

**MSN-90 A 75** is more than a hanger.  
It is an acoustic hanger with fast adjustment to  
first profile **C** o **STUD**. The profile is fixed with a  
simple gesture making him an **innovative** and  
**unique** product.

We use the latest technology in the production  
such as: renovated polymers (**KRAIBURG-TPE**)  
tested according to standard **UNE-EN ISO  
10846-1:2009** and placed in the sides on the  
steel spiral.

The steel spring is manufactured according to  
**DIN 2095 UNE EN 10270**, with **BLUE EPOXY**  
treatment.

Manufacturer of **ANTIVIBRATION** systems



\*SENOR Aisladores Acústicos



# CONSTRUCTION Catalogue 2021

## HYBRID HANGER WITH DIRECT FASTENING TO **C** PROFILES or **STUD**

Ref. SE-MSN-90 A 75



### ACOUSTIC / HYBRID Ceiling

**STEEL SPRING:** it provides a high level of isolation to vibrations in the range of **low/medium** frequencies (Hz).

**RENOVATED POLYMERS:** they have a better damping factor and a higher degree of isolation to vibration in the range of **medium/high** frequencies (Hz).

**COMBINATION:** the combination makes possible launch onto the market the best hanger of the moment and reduce the vibrations in the range of **exciter** frequencies.

It is available in several metrics: 6, 8 and 10.

### LOAD RANGE (KG)

It is recommended to loads between **30 kg** and **75 kg** of maximum load.  
(Strongly recommended not to exceed this limit in order to prevent overstressing the polymer).

**RESONANCE** frequency: 3-7 Hz.

# CONSTRUCTION Catalogue 2021

## HYBRID HANGER WITH DIRECT FASTENING TO C PROFILES or STUD

Ref. SE-MSN-90 A 75

### Laboratory tests carried out according to UNE-EN ISO 10846-1:2009

Acoustic and vibration. Measurement in the laboratory of vibro-acoustic transfer properties of elastic elements.

Manufacturer of **ANTIVIBRATION** systems

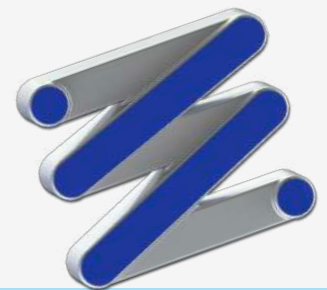
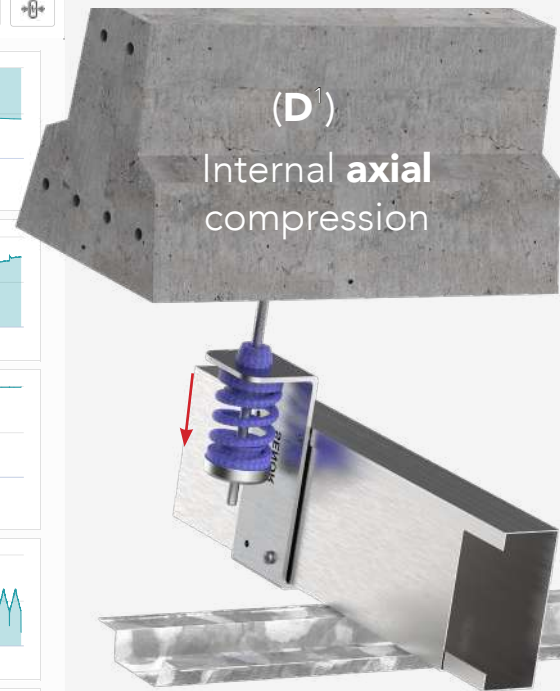
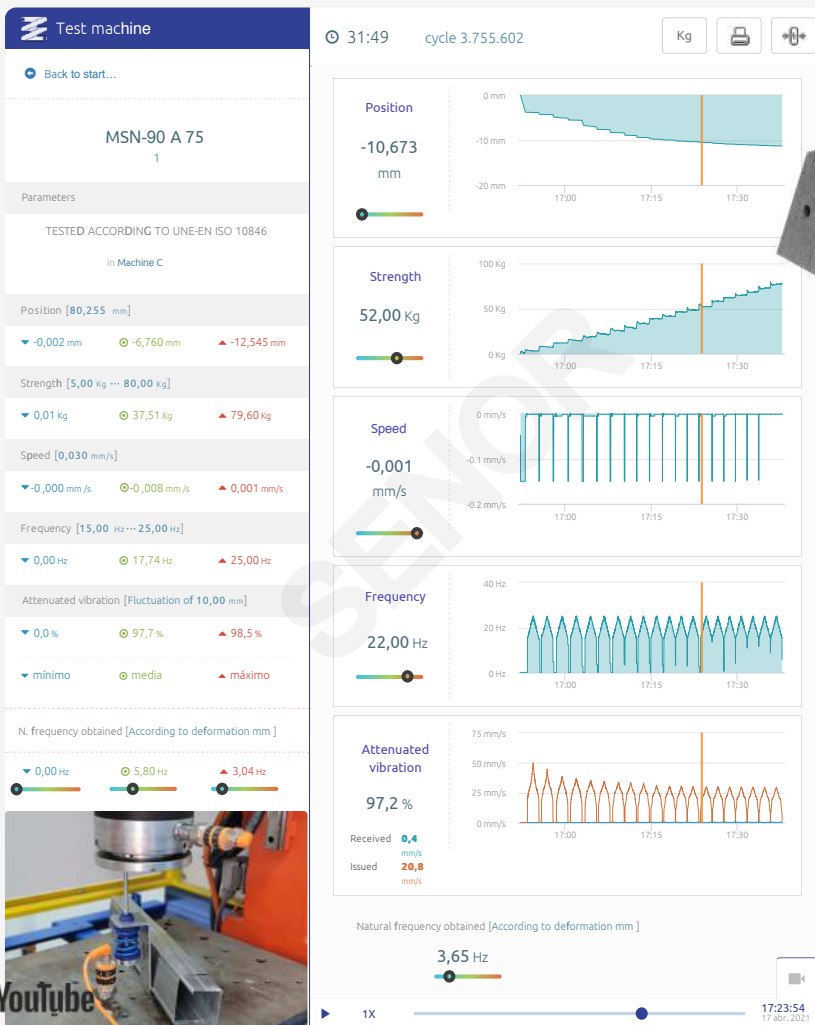





# CONSTRUCTION Catalogue 2021

## **HYBRID** HANGER WITH **DIRECT** FASTENING TO **C** PROFILES or **STUD**

Ref. SE-MSN-90 A 75

### LABORATORY RESULTS

Chart 1

**ACOUSTIC / HYBRID** Ceiling



**Patented**

BLUE RUBBER & SPRING:  
Available references

- 1°- SE-MSN-90 A 75/M6.
- 2°- SE-MSN-90 A 75/M8.
- 3°- SE-MSN-90 A 75/M10.

# CONSTRUCTION Catalogue 2021

## HYBRID HANGER WITH DIRECT FASTENING TO C PROFILES or STUD

Ref. SE-MSN-90 A 75

Patented

ACOUSTIC / HYBRID Ceiling

Manufacturer of **ANTIVIBRATION** systems

Chart 2

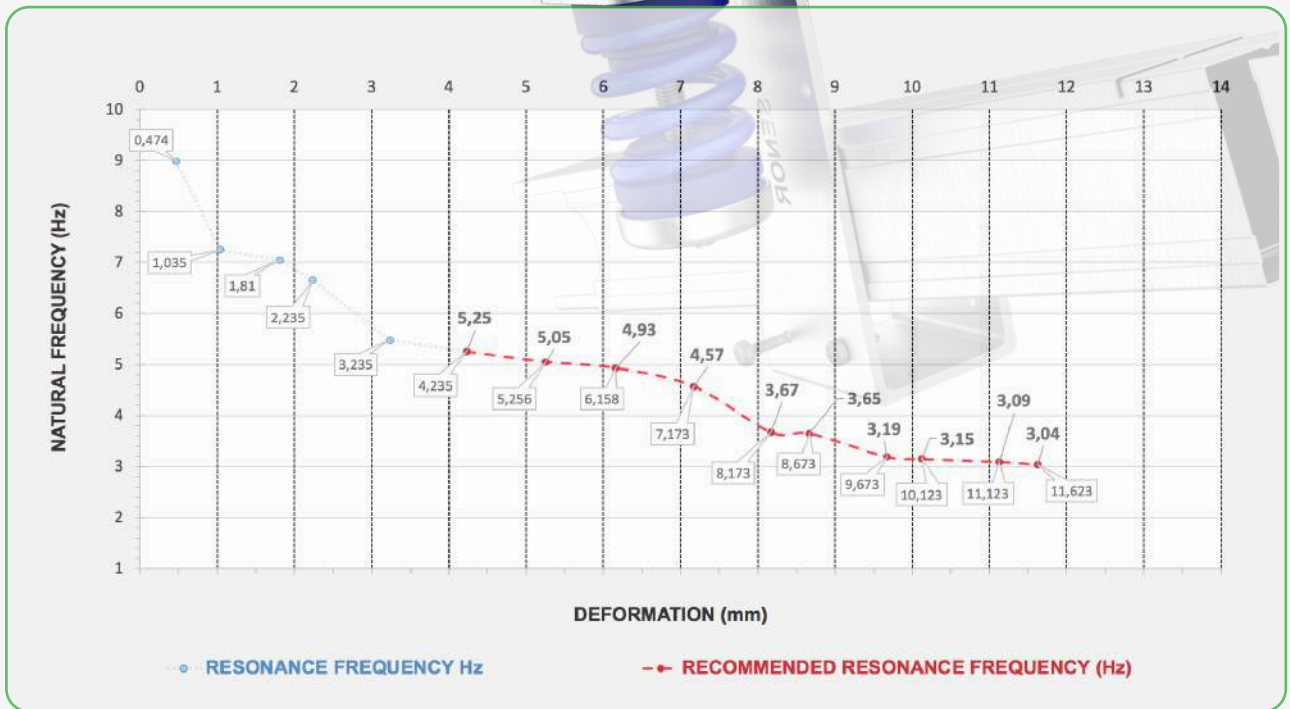

Ref. SE-MSN-90 A 75

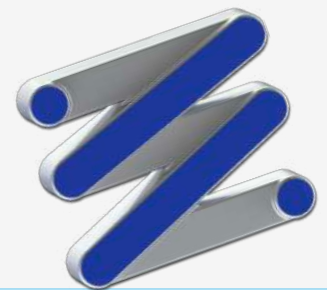

\*SENOR Aisladores Acústicos



# CONSTRUCTION Catalogue 2021

**HYBRID HANGER WITH  
DIRECT FASTENING TO C PROFILES or STUD**

Ref. SE-MSN-90 A 75

## LABORATORY RESULTS

Chart 3

**ACOUSTIC / HYBRID Ceiling**



**Patented**

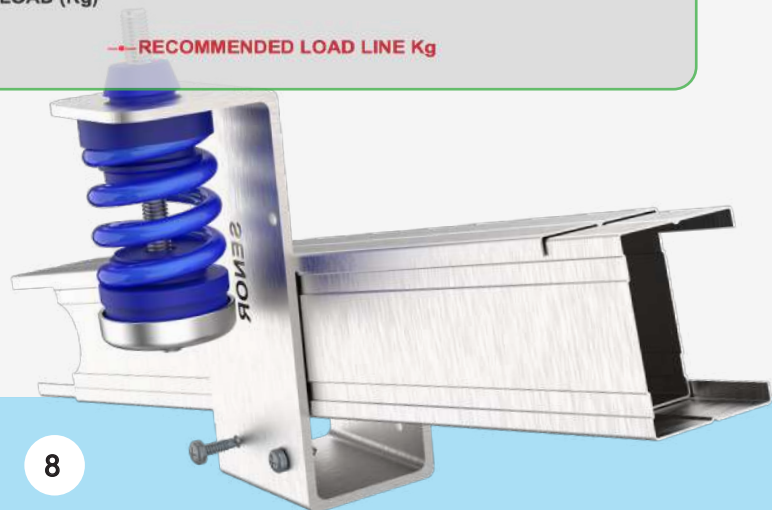

# CONSTRUCTION Catalogue 2021

## HYBRID HANGER WITH DIRECT FASTENING TO C PROFILES or STUD

Ref. SE-MSN-90 A 75

### DRAWING VIEWS

Manufacturer of **ANTIVIBRATION** systems

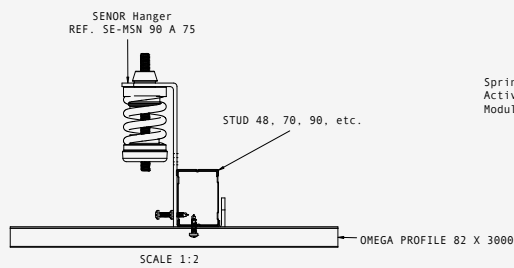

Spring diameter: 5,3 mm  
Active coils: 4,5  
Modulus of rigidity: 72864

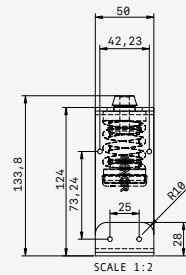
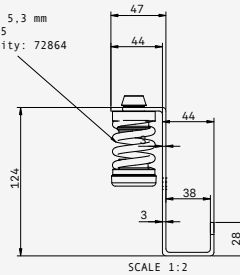

**Patented**

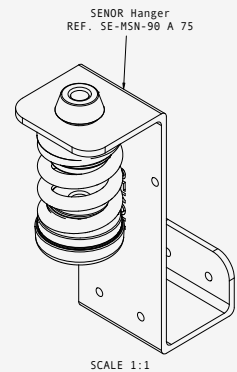
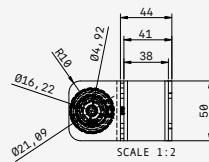
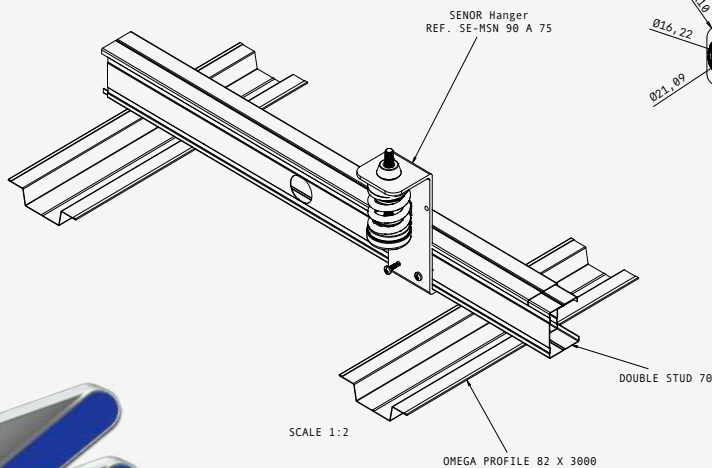

|                              |          |        |
|------------------------------|----------|--------|
| TÍTULO                       |          |        |
| MSN-90 A 75                  |          |        |
| ÚLTIMA ACTUALIZACIÓN         | UNIDADES | H33A   |
| 05/25/21                     | mm       | 1 / 1  |
| PROYECCIÓN EN DISEÑO EUROPEO | ESCALA   | TAMAÑO |
|                              | 1:20     | A2     |

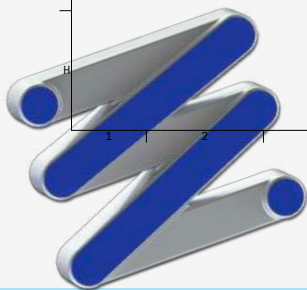

**SEÑOR**







# CONSTRUCTION Catalogue 2021

**HYBRID HANGER WITH  
DIRECT FASTENING TO C PROFILES or STUD**

Ref. SE-MSN-90 A 75

## Mechanical test LABORATORY

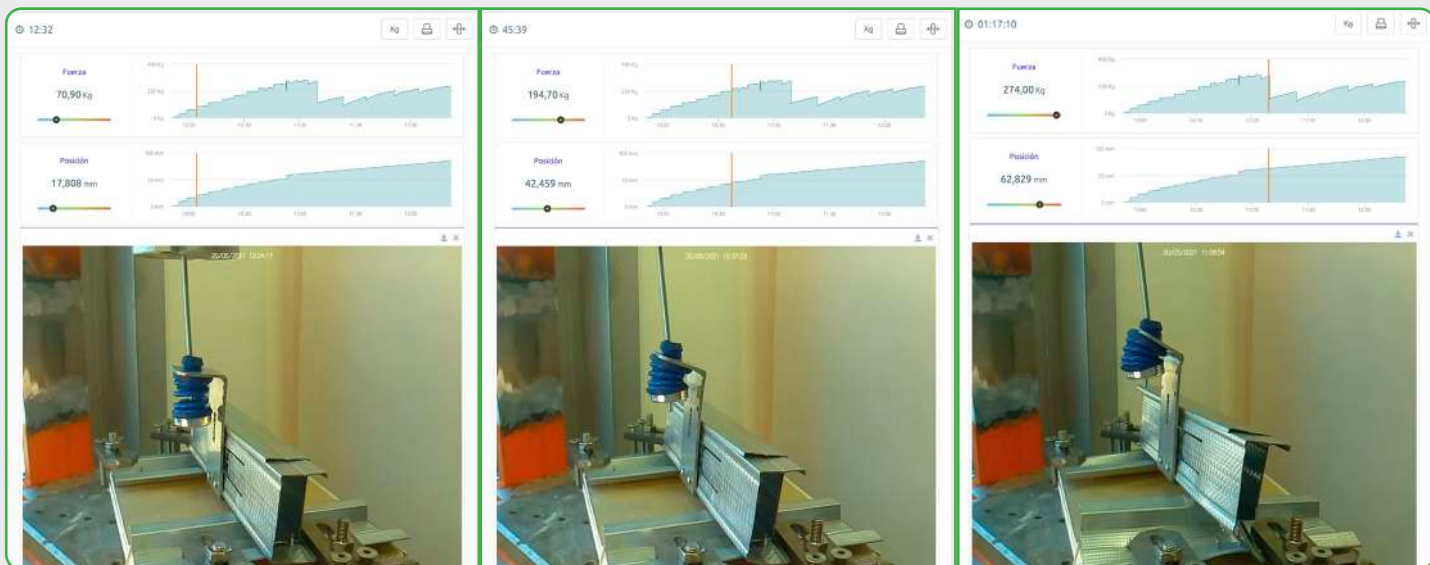

Test layout: 70,9 kg

**MSN-90 A 75**

In this test, the hanger is subjected to load inside the parameters designed to the product.

**Ref. SE-MSN-90 A 75**

**Patented**

Test layout: 194,7 kg

**MSN-90 A 75**

In this test, the hanger is subjected to load out of the parameters designed to the product.

We can see steel spring and polymers very compressed.

Test layout: 274,0 kg

**MSN-90 A 75**

Failure mode.  
The components are deformed and the profiles are twisted reaching its elastic limit.

# CONSTRUCTION Catalogue 2021

## **HYBRID** HANGER WITH **DIRECT** FASTENING TO **C** PROFILES or **STUD**

Ref. **SE-MSN-90 A 75**

Manufacturer of **ANTIVIBRATION** systems

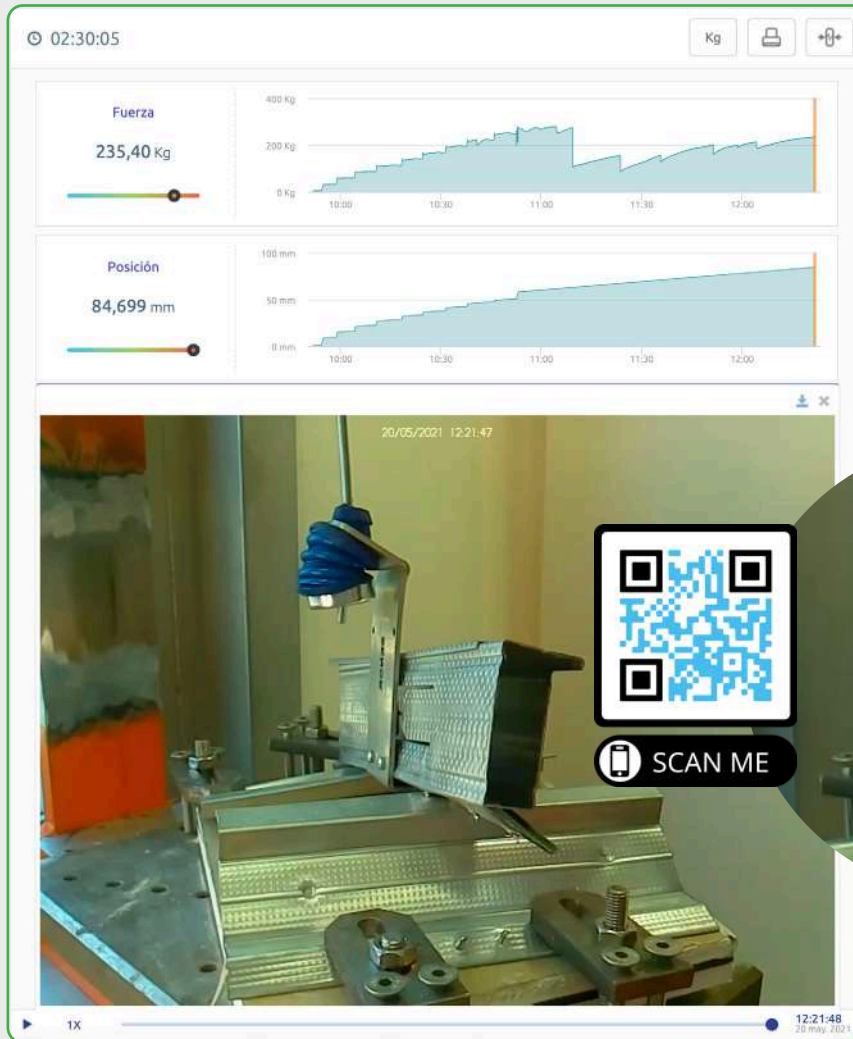

### **MSN-90 A 75**

Failure mode.

The elastic limit of the component is reached at **274 kg**.

The burst test is concluded.

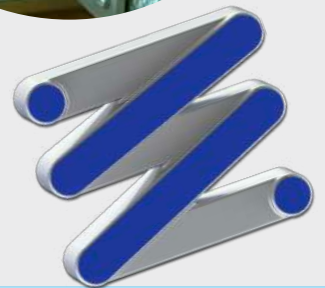

\*SENOR Aisladores Acústicos



# CONSTRUCTION Catalogue 2021

**HYBRID HANGER WITH  
DIRECT FASTENING TO C PROFILES or STUD**

Ref. SE-MSN-90 A 75

## Certificate of Compliance



SEÑOR certifies:

The **MSN-90 model** in the construction range for the suspension of low acoustic false ceilings under slab has an **optimal lifespan of 10 years** provided that the installation is carried out under **ordinary environmental conditions** and are not exposed to chemical components that could degrade the product. The **MSN-90 model** strictly complies with **UNE** (Spanish Association for Standardization) **UNE 100-153-88**: air conditioning: vibration insulators: design criteria.

**SEÑOR** declares under its responsibility that the following components for suspended ceiling in buildings strictly complies with the technical sections of installation mentioned in the technical documentation of the product.

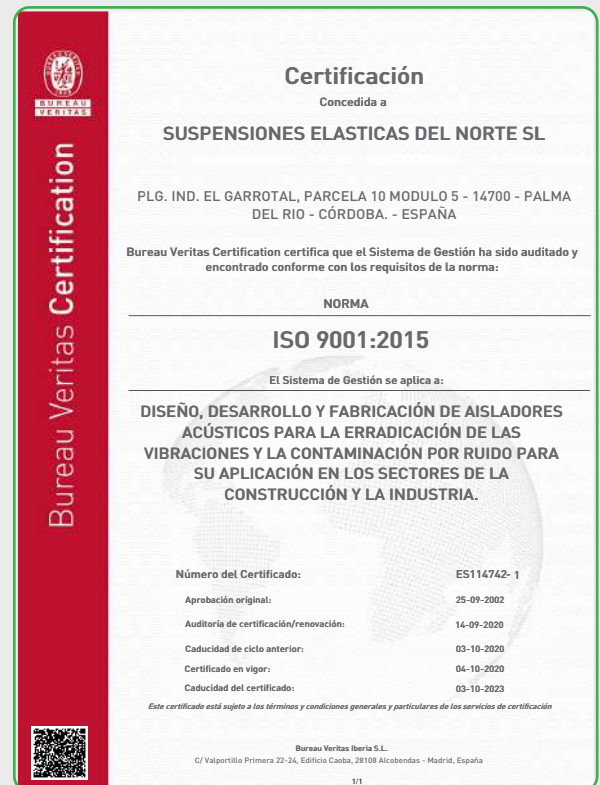

# CONSTRUCTION Catalogue 2021

## **HYBRID HANGER WITH DIRECT FASTENING TO C PROFILES or STUD**

Ref. SE-MSN-90 A 75

Manufacturer of **ANTIVIBRATION** systems

### Warning

Relevant information

**SEÑOR** reserves the right to make changes in specifications at any time without prior notice. It is a responsibility of the user to use the latest and updated version of the product data sheets.

**A copy of which will be available on request.** This information and, in particular, relative recommendations to the application and final use of the product, are given in good faith, based on **SEÑOR** knowledge and experience of its products, provided that they are correctly installed in ordinary circumstances and within its useful life.



Ref. SE-MSN-90 A 75

**Patented**



\*SEÑOR Aisladores Acústicos

