

# Preisliste INDUSTRIE 2023

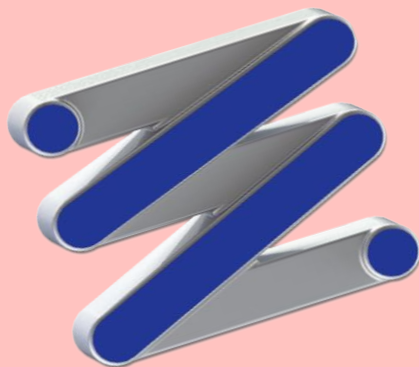

\*SENOR Antivibration System

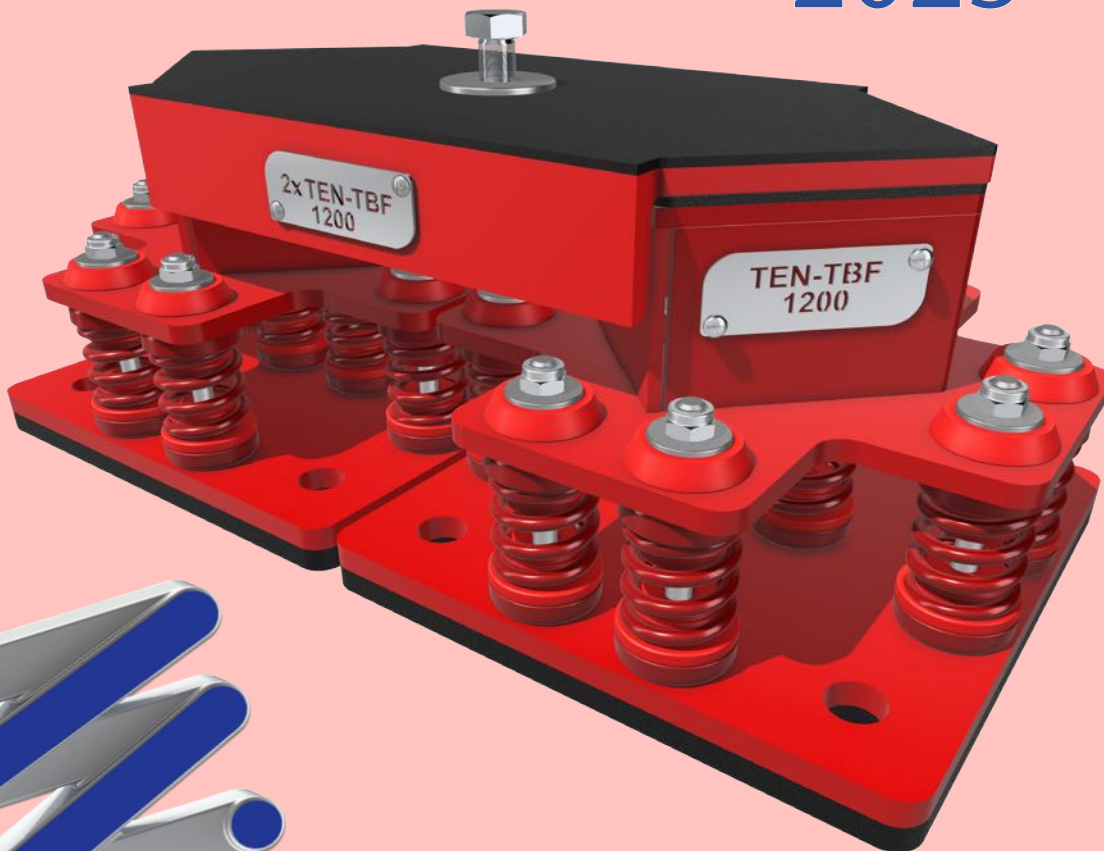

**SENOR**  
Hersteller von Antivibrationssysteme

1  
Auflage

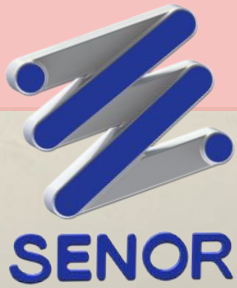

# Preisliste INDUSTRIE 2023

**1ª AUSGABE: GÜLTIG AB DEN 1 JANUAR VON 2023**

**Diese Preisliste könnte modifiziert werden im falle einer erhöhung von unseren materialen würde man mit 15 tage vorab mitgeteilt.**



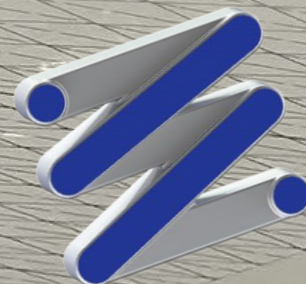

## LUFTKANAL / FASER & METALL

Referenz	Belastung mín./máx.	UVP €/St
Reference	minimum/maximum load	RRP €/Unit
<b>Luftkanal FASER</b>		
SE-AS-PLUS/L4 A.FASER	-	2,78 €
<b>SE-AS-PLUS/L6 A.FASER</b>	-	<b>2,78 €</b>
<b>Luftkanal METALL</b>		
SE-AS-PLUS/L6 A.METALL	-	5,26 €
<b>SE-AS-PLUS/L8 A.METALL</b>	-	<b>6,30 €</b>
<b>Luftkanal METALL HYBRID</b>		
SE-AS+AC/LG 15 METALL	3 kg bis 15 kg	9,78 €
<b>SE-AS+AC/LG 30 METALL</b>	<b>15 kg bis 30 kg</b>	<b>9,85 €</b>
SE-AS+AC/LG 50 METALL	30 kg bis 50 kg	9,91 €
<b>SE-AS+AC/LG 75 METALL</b>	<b>50 kg bis 75 kg</b>	<b>10,00 €</b>

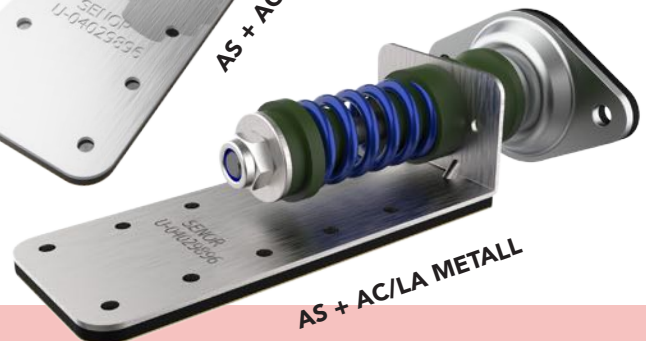
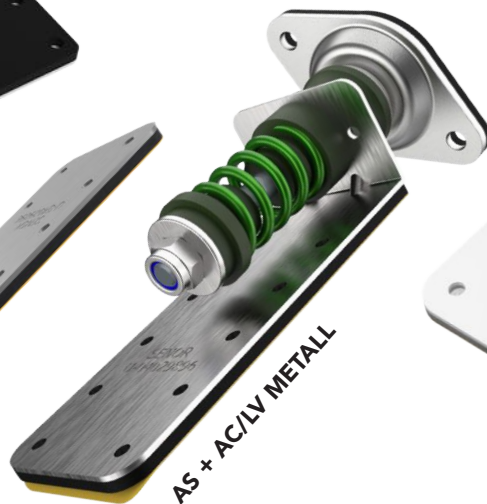
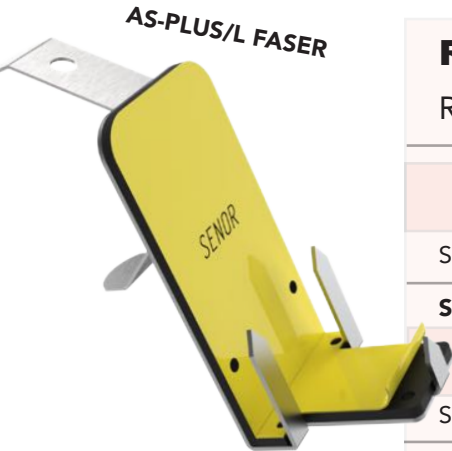

Hersteller von **ANTIVIBRATIONSSYSTEME**



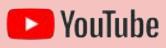

# Preisliste INDUSTRIE

\*SENOR Antivibration System

## 2023



# SENOR

\*Fotos von Kunden erhalten.

## MASCHINEN HÄNGEND / **DECKE**

Referenz Reference	Belastung mín/máx minimum/maximum load	UVP €/St RRP €/Unit
<b>FAN-COILS / GUMMI</b>		
SE-TA-30/M6	8 kg bis 30 kg	2,38 €
<b>SE-TA-30/M8</b>	<b>8 kg bis 30 kg</b>	<b>2,48 €</b>
SE-TA-50/M6	27 kg bis 50 kg	2,46 €
<b>SE-TA-50/M8</b>	<b>27 kg bis 50 kg</b>	<b>2,53 €</b>
SE-TAC-30/M6	8 kg bis 30 kg	2,64 €
<b>SE-TAC-30/M8</b>	<b>8 kg bis 30 kg</b>	<b>2,73 €</b>
SE-TAC-50/M6	27 kg bis 50 kg	2,72 €
<b>SE-TAC-50/M8</b>	<b>27 kg bis 50 kg</b>	<b>2,82 €</b>
SE-TAF-10 G/M8	3 kg bis 10 kg	3,77 €
<b>SE-TAF-20 V/M8</b>	<b>8 kg bis 20 kg</b>	<b>3,91 €</b>
<b>FAN-COILS / FEDER</b>		
SE-TCM-15 G/INOX/M8	3 kg bis 15 kg	6,54 €
<b>SE-TCM-30 V/INOX/M8</b>	<b>15 kg bis 30 kg</b>	<b>6,68 €</b>
SE-TCM-50 A/INOX/M8	30 kg bis 50 kg	6,77 €
<b>SE-TCM-75 R/INOX/M8</b>	<b>50 kg bis 75 kg</b>	<b>6,84 €</b>
SE-SCM-20 G/INOX/M8	3 kg bis 20 kg	10,14 €
<b>SE-SCM-45 V/INOX/M8</b>	<b>15 kg bis 45 kg</b>	<b>10,30 €</b>
SE-SCM-75 A/INOX/M8	30 kg bis 75 kg	10,48 €
<b>SE-SCM-120 R/INOX/M8</b>	<b>60 kg bis 120 kg</b>	<b>10,62 €</b>

Hersteller von **ANTIVIBRATIONSSYSTEME**

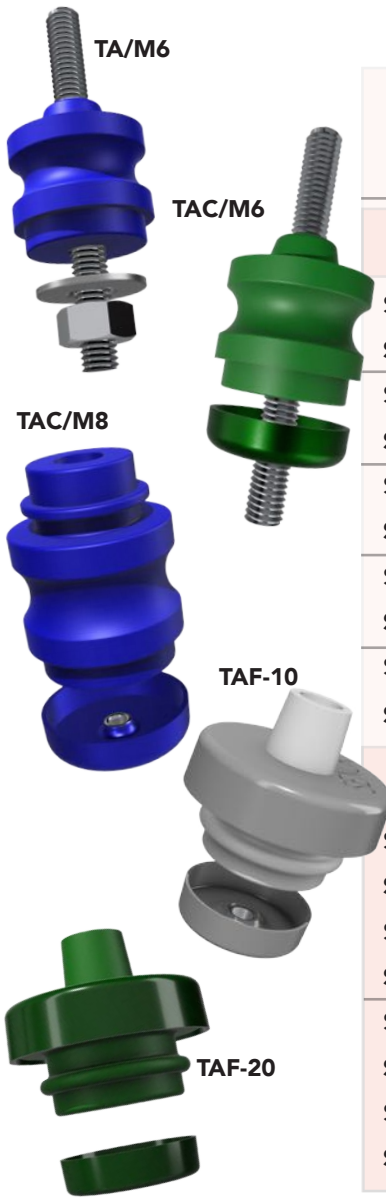

**Neu**

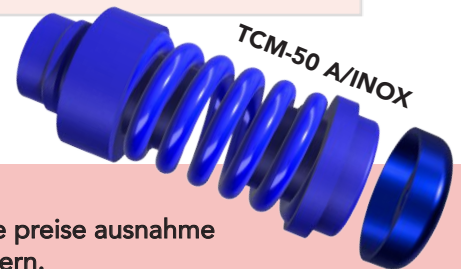
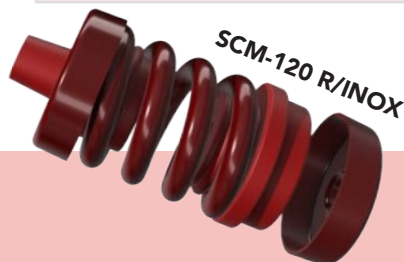



# Preisliste INDUSTRIE 2023

\*SENOR Antivibration System



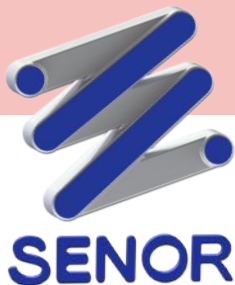

# Preisliste INDUSTRIE 2023

## MASCHINEN HÄNGEND / **DECKE**

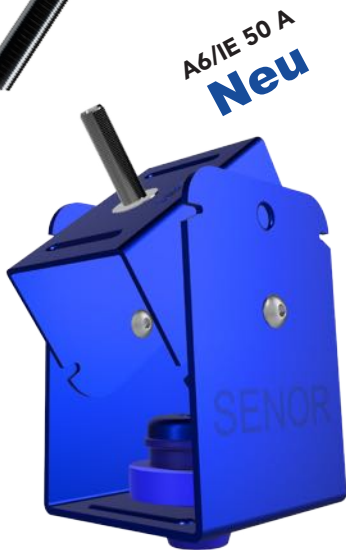

Referenz	Belastung mín/máx	UVP €/St
Reference	minimum/maximum load	RRP €/Unit

### LÜFTUNGSKASTEN / **GUMMI**

SE-A6/IH-30 V/M8	<b>Neu</b>	8 kg bis 30 kg	10,78 €
SE-A6/IH-50A/M8	<b>Neu</b>	27 kg bis 50 kg	11,51 €
SE-A6/IE-30 V/M8	<b>Neu</b>	8 kg bis 30 kg	12,05 €
SE-A6/IE-50A/M8	<b>Neu</b>	27 kg bis 50 kg	12,79 €

### ABSAUGER UND RÖHRE / **GUMMI**

SE-TAV/4000 G		3 kg bis 20 kg	55,58 €
<b>SE-TAV/4000 V</b>		<b>15 kg bis 35 kg</b>	<b>58,92 €</b>
SE-TAV/4000 A		30 kg bis 45 kg	62,28 €
<b>SE-TAV/4000 R</b>		<b>40 kg bis 60 kg</b>	<b>65,34 €</b>

\* Produkt verfügbar in metrischen : 8, 10, 12, 14 & 16

SE-TAV/4000 EG	<b>Neu</b>	3 kg bis 20 kg	59,42 €
<b>SE-TAV/4000 EV</b>	<b>Neu</b>	<b>15 kg bis 35 kg</b>	<b>62,76 €</b>
SE-TAV/4000 EA	<b>Neu</b>	30 kg bis 45 kg	66,11 €
<b>SE-TAV/4000 ER</b>	<b>Neu</b>	<b>40 kg bis 60 kg</b>	<b>69,17 €</b>

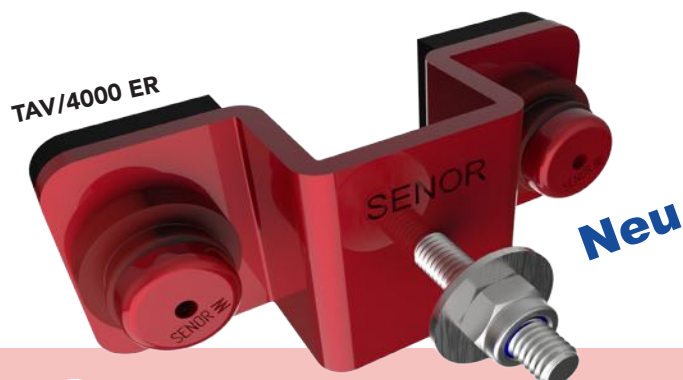
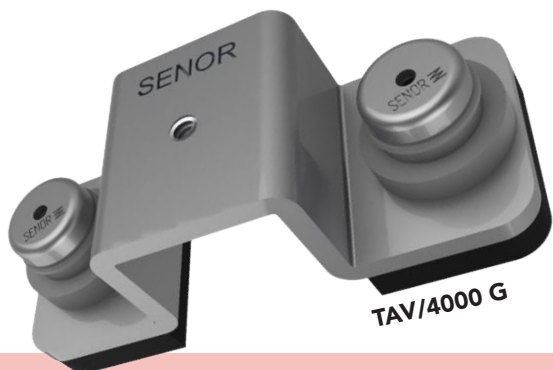

Hersteller von **ANTIVIBRATIONSSYSTEME**



# Preisliste INDUSTRIE

## 2023

\*SENOR Antivibration System

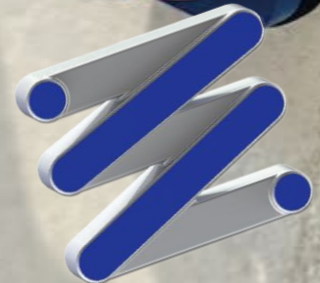

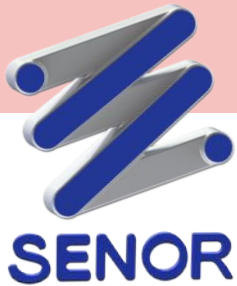

# Preisliste INDUSTRIE 2023

## AUFHÄNGUNG VON ROHRLEITUNGEN

Referenz	Belastung mín/máx	UVP €/St
Reference	minimum/maximum load	RRP €/Unit
<b>RÖHRE / GUMMI</b>		
SE-ATB-50	<b>Neu</b> NÄCHSTE ERSTAUSFÜHRUNG	9,60 €

**\* Akustische und Adaptive Klemme:**

Es erlaubt verschiedene rohrgrößen zu befestigen .



**NEU**  
ATB-50

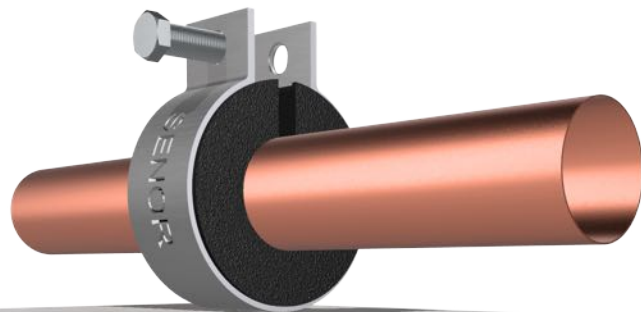

Hersteller von **ANTIVIBRATIONSSYSTEME**



### AUFHÄNGUNG VON ROHRLEITUNGEN

Referenz	Belastung mín/máx	UVP €/St
Reference	minimum/maximum load	RRP €/Unit
<b>RÖHRE / GUMMI</b>		

SE-TDBI-50/M8

NÄCHSTE ERSTAUSFÜHRUNG

**Neu**

10,37 €

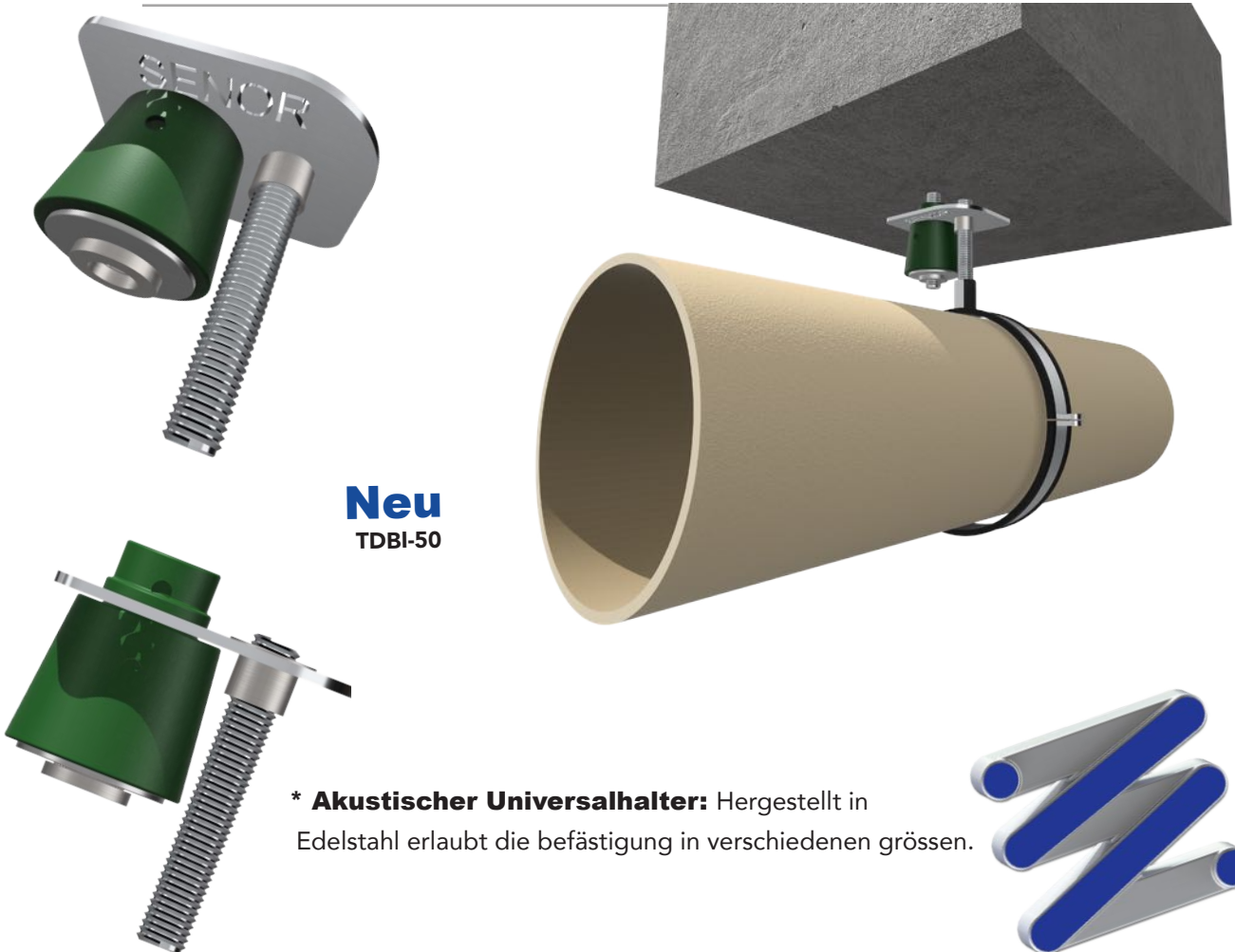

\* **Akustischer Universalhalter:** Hergestellt in Edelstahl erlaubt die befästigung in verschiedenen grössen.

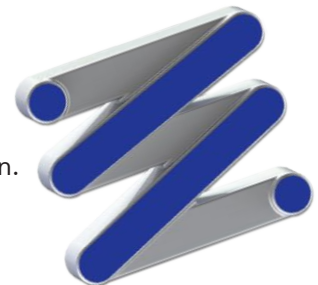

## MASCHINEN HÄNGEND / **DECKE**

M 8

A4M8-MIXTO/20 G



A4M8-MIXTO/45 V

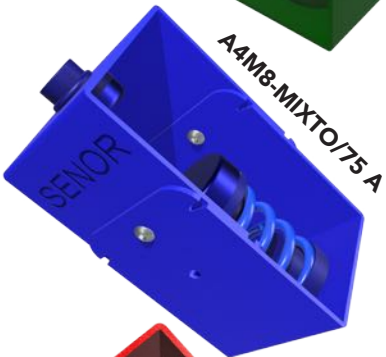

A4M8-MIXTO/75 A

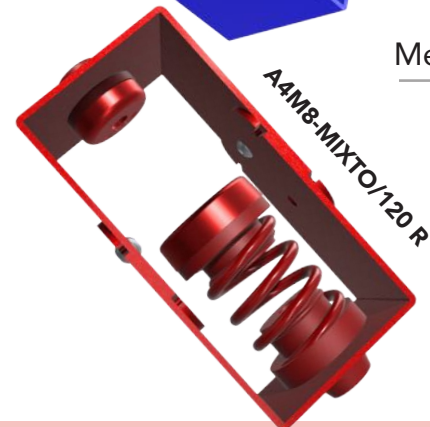

A4M8-MIXTO/120 R

Metrisch 10 →

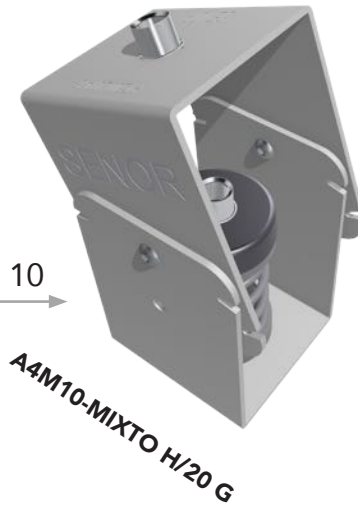

A4M10-MIXTO H/20 G



A4M10-MIXTO H/45 V



A4M10-MIXTO H/120 R

Referenz	Belastung mín/máx	UVP €/St
Reference	minimum/maximum load	RRP €/Unit
<b>ABSAUGER / FEDER + GUMMI</b>		
SE-A4M8-MIXTO/20 G	3 kg bis 20 kg	21,90 €
<b>SE-A4M8-MIXTO/45 V</b>	<b>15 kg bis 45 kg</b>	<b>22,14 €</b>
SE-A4M8-MIXTO/75 A	30 kg bis 75 kg	22,34 €
<b>SE-A4M8-MIXTO/120 R</b>	<b>60 kg bis 120 kg</b>	<b>22,49 €</b>
SE-A4M10-MIXTO H/20 G	3 kg bis 20 kg	22,00 €
<b>SE-A4M10-MIXTO H/45 V</b>	<b>15 kg bis 45 kg</b>	<b>22,21 €</b>
SE-A4M10-MIXTO H/75 A	30 kg bis 75 kg	22,43 €
<b>SE-A4M10-MIXTO H/120 R</b>	<b>60 kg bis 120 kg</b>	<b>22,75 €</b>

Hersteller von **ANTIVIBRATIONSSYSTEME**



# Preisliste INDUSTRIE

## 2023

\*SENOR Antivibration System

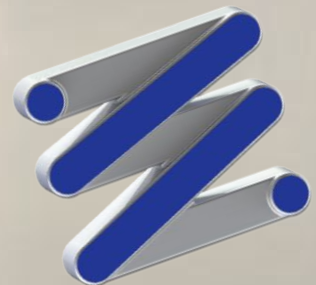

**SENOR**

## MASCHINEN HÄNGEND / **DECKE**

Referenz	Belastung mín/máx	UVP €/St
Reference	minimum/maximum load	RRP €/Unit
<b>LÜFTUNGSKÄSTEN / FEDER + GUMMI</b>		
SE-A4MIXTO E 20 G/I-M8	3 kg bis 20 kg	<b>Neu</b> 22,79 €
<b>SE-A4MIXTO E 45 V/I-M8</b>	<b>15 kg bis 45 kg</b>	<b>Neu</b> 22,95 €
SE-A4MIXTO E 75 A/I-M8	30 kg bis 75 kg	<b>Neu</b> 23,17 €
<b>SE-A4MIXTO E 120 R/I-M8</b>	<b>60 kg bis 120 kg</b>	<b>Neu</b> 23,34 €

<b>LÜFTUNGSKÄSTEN / MUELLE + GOMA</b>			
SE-A4MIXTO H 20 G/I-M8	3 kg bis 20 kg	<b>Neu</b>	22,79 €
<b>SE-A4MIXTO H 45 V/I-M8</b>	<b>15 kg bis 45 kg</b>	<b>Neu</b>	22,95 €
SE-A4MIXTO H 75 A/I-M8	30 kg bis 75 kg	<b>Neu</b>	23,17 €
<b>SE-A4MIXTO H 120 R/I-M8</b>	<b>60 kg bis 120 kg</b>	<b>Neu</b>	23,34 €



A4MIXTO E 45 V/I-M8



A4MIXTO E 75 A/I-M8

A4MIXTO H 45 V/I-M8



A4MIXTO H 75 A/I-M8

A4MIXTO E 120 R/I-M8



Hersteller von **ANTIVIBRATIONSSYSTEME**



## 2023

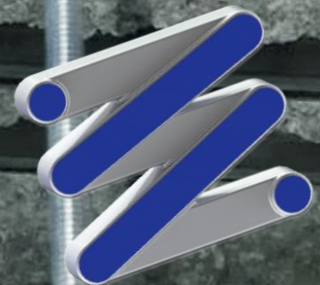

# SENOR

## MASCHINEN HÄNGEND / DECKE

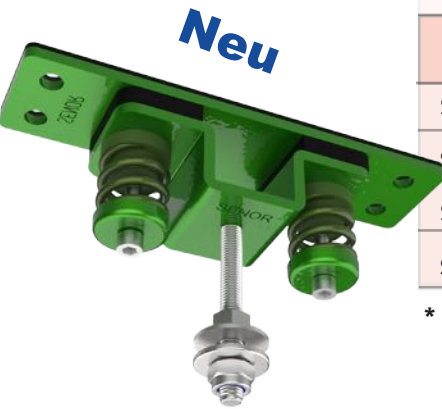
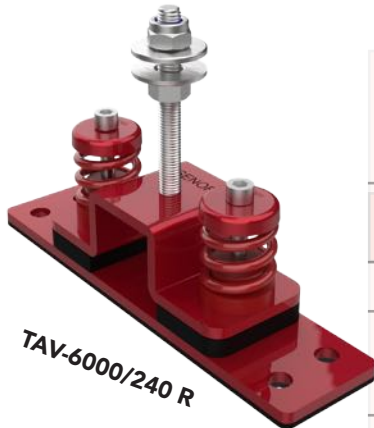

TAV-6000/90 V

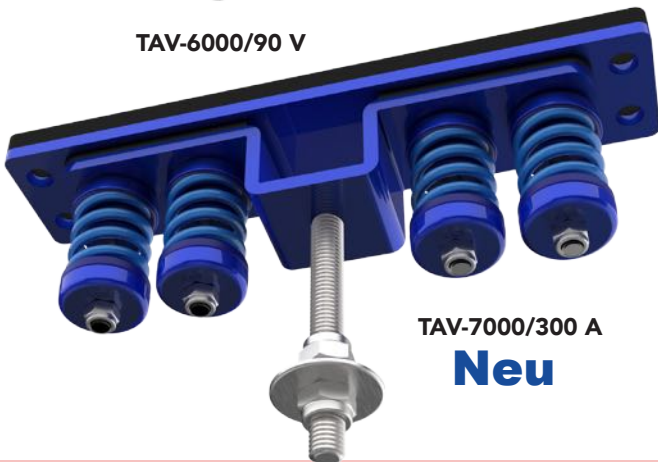

Referenz	Belastung mín/máx	UVP €/St	
Reference	minimum/maximum load	RRP €/Unit	
<b>KÜHLER / FEDER + GUMMI</b>			
SE-TAV-6000/40 G	6 kg bis 40 kg	Neu	82,48 €
SE-TAV-6000/90 V	30 kg bis 90 kg	Neu	85,84 €
SE-TAV-6000/150 A	60 kg bis 150 kg	Neu	89,20 €
SE-TAV-6000/240 R	120 kg bis 240 kg	Neu	92,55 €
<b>SCHWER- MASCHINEN / FEDER + GUMMI</b>			
SE-TAV-7000/80 G	12 kg bis 80 kg	Neu	127,04 €
SE-TAV-7000/180 V	60 kg bis 180 kg	Neu	127,67 €
SE-TAV-7000/300 A	120 kg bis 300 kg	Neu	128,32 €
SE-TAV-7000/480 R	240 kg bis 480 kg	Neu	128,97 €

\* Produkt erhältlich in verschiedenen metriken: 8, 10, 12, 14 & 16.



Hersteller von ANTIVIBRATIONSSYSTEME



2023



**SENOR**

## SPLIT / HAUSHALT



BF-35



BF-45

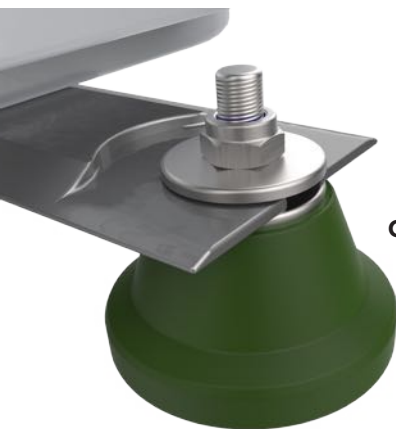

CF-20 V



CF-10 G

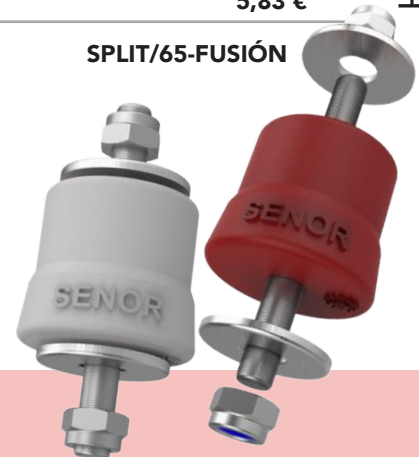

SPLIT/65-FUSIÓN

Referenz	Belastung mín/máx	UVP €/St
Reference	minimum/maximum load	RRP €/Unit
<b>MASCHINEN - WINKEL / GUMMI</b>		
SE-BF-25	5 kg bis 25 kg	3,20 €
<b>SE-BF-35</b>	<b>25 kg bis 35 kg</b>	<b>3,23 €</b>
SE-BF-45	35 kg bis 45 kg	3,28 €
<b>SE-BF-60</b>	<b>45 kg bis 60 kg</b>	<b>3,30 €</b>
* Produkt erhältlich in metrik: 8.		
SE-SPLIT/65-FUSIÓN	PACK von 2 STK BF-25 + 2 StS BF-60	12,70 €
<b>SE-SPLIT/70-FUSIÓN</b>	<b>PACK von 2 STK BF-45 + 2 StS BF-60</b>	<b>12,90 €</b>
* Produkt erhältlich in metrik: 8.		
<b>MASCHINEN - BODEN / GUMMI</b>		
SE-CF-10 G	4 kg bis 12 kg	5,27 €
<b>SE-CF-20 V</b>	<b>9 kg bis 24 kg</b>	<b>5,54 €</b>
SE-CF-30 A	15 kg bis 35 kg	5,67 €
<b>SE-CF-50 R</b>	<b>30 kg bis 50 kg</b>	<b>5,83 €</b>

Hersteller von **ANTIVIBRATIONSSYSTEME**



# Preisliste INDUSTRIE 2023

\*SENOR Antivibration System



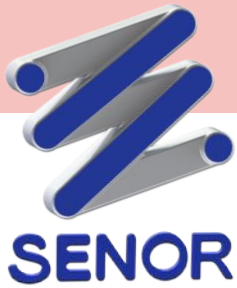

# Preisliste INDUSTRIE 2023

## SPLIT / HAUSHALT



Referenz	Belastung mín/máx	UVP €/St
Reference	minimum/maximum load	RRP €/Unit

### MASCHINEN - BODEN / GUMMI

SE-SPLIT/75-FUSIÓN	PACK von 2 StS CF-10 G + 2 StS CF-50 R	20,73 €
--------------------	--	---------

\* Produkt erhältlich in metrik: 8.

### MASCHINEN - BODEN / VERSTELLBAR GUMMI

SE-CR-10 G	3 kg bis 10 kg	7,82 €
SE-CR-20 V	8 kg bis 20 kg	7,85 €
SE-CR-30 A	15 kg bis 30 kg	7,88 €
SE-CR-50 R	25 kg bis 50 kg	7,93 €

\* Produkt erhältlich in metrik: 8.

### MASCHINEN - WINKEL / FEDER + GUMMI

SE-TB/INOX E-20 G	3 kg bis 20 kg	23,64 €
SE-TB/INOX E-45 V	15 kg bis 45 kg	24,09 €
SE-TB/INOX E-75 A	30 kg bis 75 kg	24,53 €
SE-TB/INOX E-120 R	60 kg bis 120 kg	25,87 €

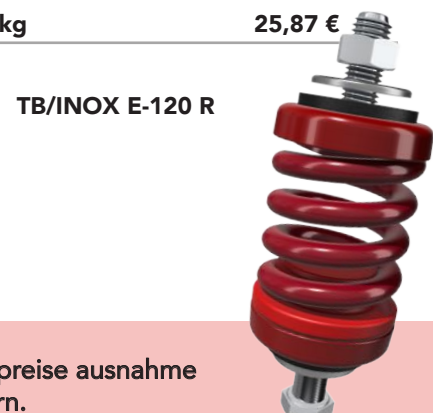

Hersteller von ANTIVIBRATIONSSYSTEME



\*SENOR Antivibration System

## 2023



# SENOR



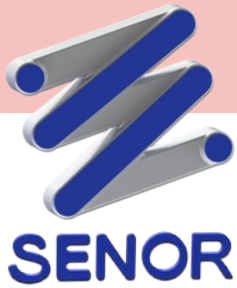

# Preisliste INDUSTRIE 2023

## SPLIT / HAUSHALT ANTI-ROLL

Neu

TBF-75 A

TBF-45 V



Referenz	Belastung mín/máx	UVP €/St
Reference	minimum/maximum load	RRP €/Unit

### MASCHINEN WINKEL / HYBRID

SE-TBF-20 G	Neu	3 kg bis 20 kg	32,56 €
SE-TBF-45 V	Neu	15 kg bis 45 kg	32,77 €
SE-TBF-75 A	Neu	30 kg bis 75 kg	33,17 €
SE-TBF-120 R	Neu	60 kg bis 120 kg	34,47 €

### MASCHINEN BODEN / HYBRID

SE-TBMF-20 G	Neu	3 kg bis 20 kg	40,27 €
SE-TBMF-45 V	Neu	15 kg bis 45 kg	41,46 €
SE-TBMF-75 A	Neu	30 kg bis 75 kg	41,98 €
SE-TBMF-120 R	Neu	60 kg bis 120 kg	42,40 €

TBF-120 R

TBMF-20 G

TBMF-75 A

TBMF-45 V

Hersteller von ANTI-VIBRATIONSSYSTEME

2023

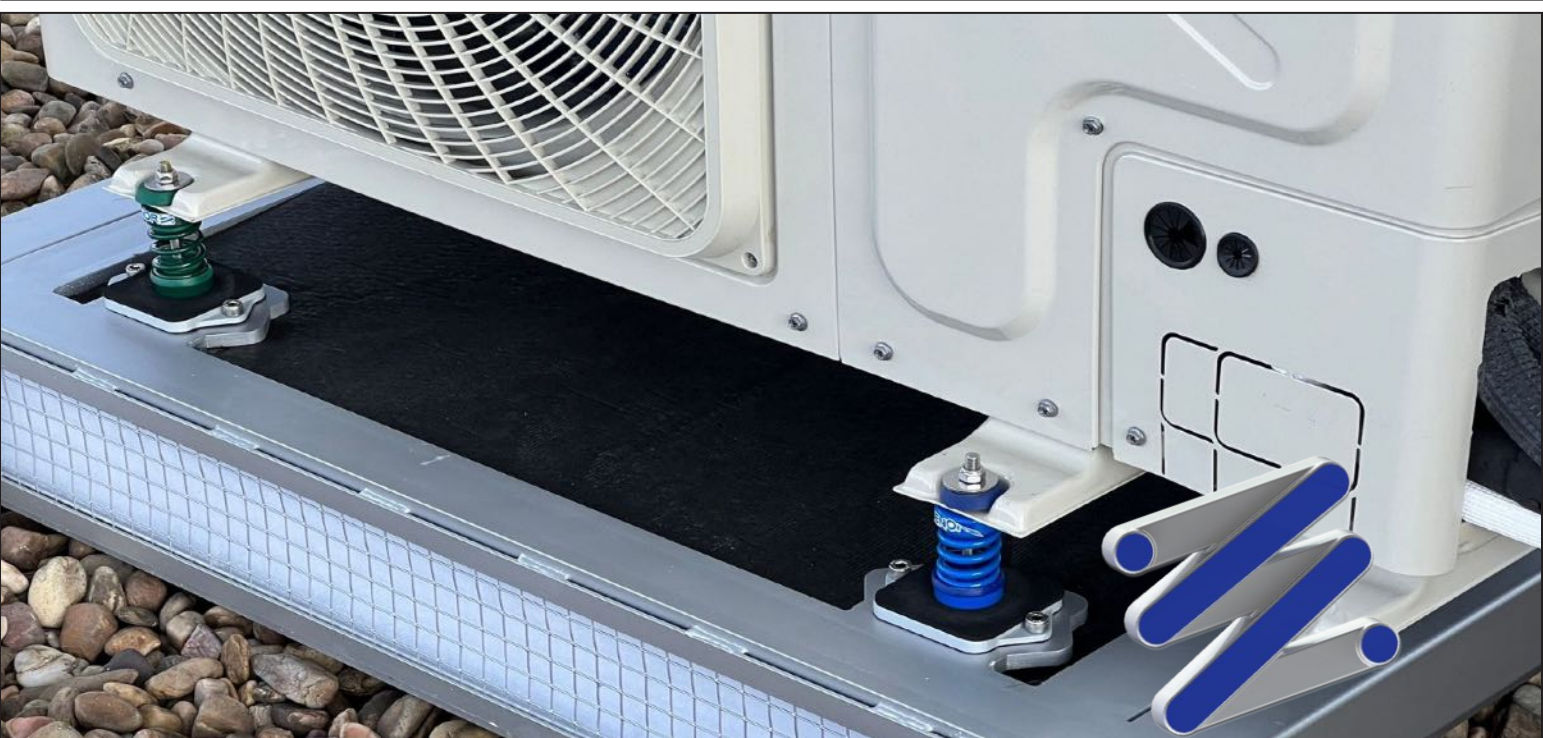



## SPLIT / HALB-INDUSTRIEL ANTI-ROLL



**Neu**

Referenz	Belastung mín/máx	UVP €/St	
Reference	minimum/maximum load	RRP €/Unit	
<b>MASCHINEN BODEN / HYBRID</b>			
SE-TBMF-ADAPTA 20 G	3 kg bis 20 kg	<b>Neu</b>	79,20 €
<b>SE-TBMF-ADAPTA 45 V</b>	<b>15 kg bis 45 kg</b>	<b>Neu</b>	<b>79,77 €</b>
SE-TBMF-ADAPTA 75 A	30 kg bis 75 kg	<b>Neu</b>	80,27 €
<b>SE-TBMF-ADAPTA 120 R</b>	<b>60 kg bis 120 kg</b>	<b>Neu</b>	<b>80,72 €</b>

\* Produkt für aussenbefestigung der Maschine.

## SPLIT / HAUSHALT

TBMF-ADAPTA 45 V

<b>MASCHINEN BODEN / HYBRID</b>			
SE-TBM/IX 20 G/M8	3 kg bis 20 kg		28,44 €
<b>SE-TBM/IX 45 V/M8</b>	<b>15 kg bis 45 kg</b>		<b>29,24 €</b>
SE-TBM/IX 75 A/M8	30 kg bis 75 kg		30,08 €
<b>SE-TBM/IX 120 R/M8</b>	<b>60 kg bis 120 kg</b>		<b>30,48 €</b>

TBM/IX 20 G

TBM/IX 75 A



Hersteller von **ANTIVIBRATIONSSYSTEME**



# Preisliste INDUSTRIE 2023

\*SENOR Antivibration System

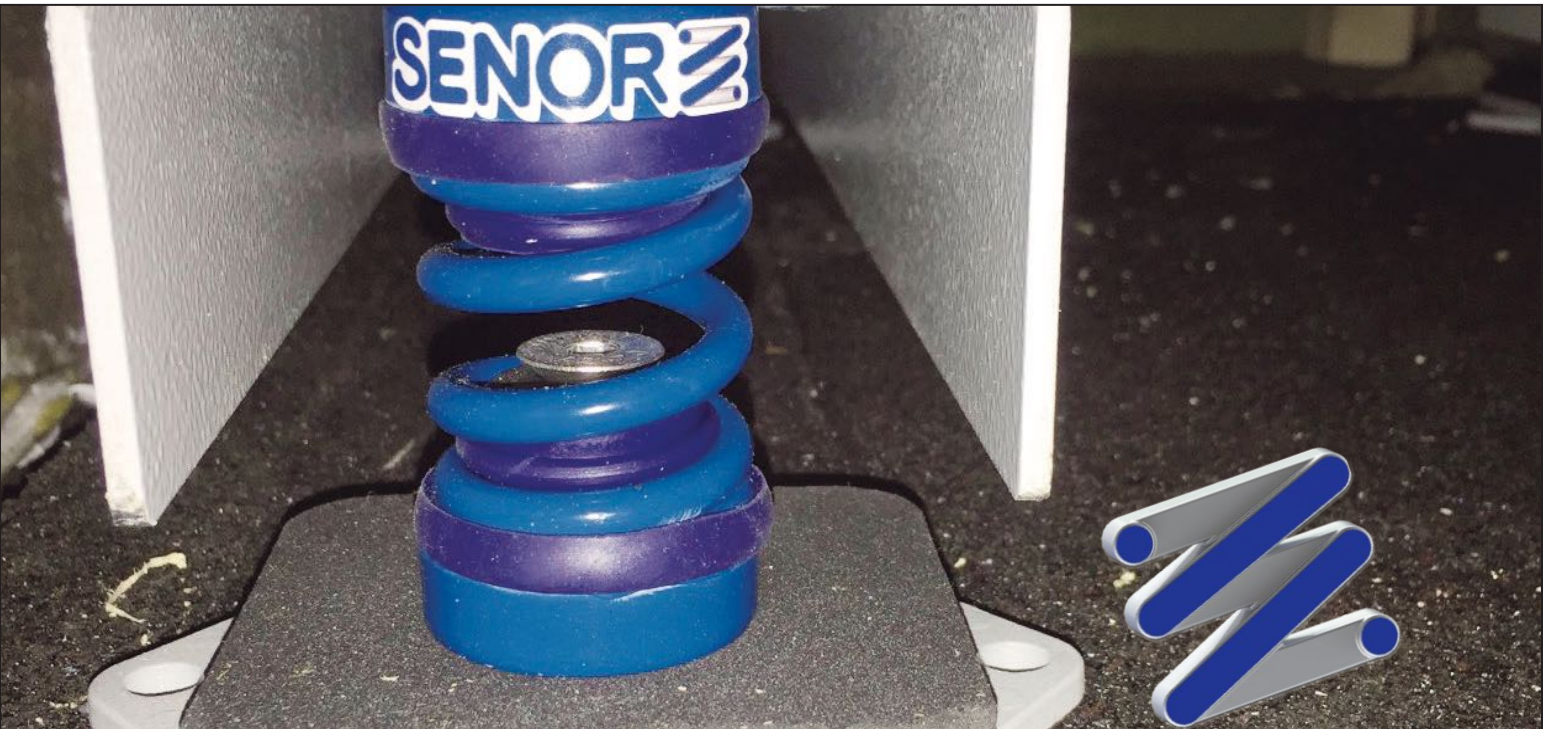

## SPLIT / HAUSHALT

TBM/IX 45 V + PT 1



TBM/IX 120 R + PT 2



Referenz	Belastung mín/máx	UVP €/St
Reference	minimum/maximum load	RRP €/Unit

### MASCHINEN BODEN / HYBRID

SE-TBM/IX 20 G + PT 1	3 kg bis 20 kg	<b>Neu</b>	43,61 €
<b>SE-TBM/IX 45 V + PT 1</b>	<b>15 kg bis 45 kg</b>	<b>Neu</b>	<b>44,42 €</b>
SE-TBM/IX 75 A + PT 1	30 kg bis 75 kg	<b>Neu</b>	45,24 €
<b>SE-TBM/IX 120 R + PT 1</b>	<b>60 kg bis 120 kg</b>	<b>Neu</b>	<b>45,65 €</b>

\* Produkt für die bodenhaltung von klimageräten ohne befestigungswinkel.

### "MITTE "

SE-TBM/IX 20 G + PT 2	3 kg bis 20 kg	<b>Neu</b>	44,90 €
<b>SE-TBM/IX 45 V + PT 2</b>	<b>15 kg bis 45 kg</b>	<b>Neu</b>	<b>45,69 €</b>
SE-TBM/IX 75 A + PT 2	30 kg bis 75 kg	<b>Neu</b>	46,53 €
<b>SE-TBM/IX 120 R + PT 2</b>	<b>60 kg bis 120 kg</b>	<b>Neu</b>	<b>46,93 €</b>

\* Produkt zum anlehnen ohne winkel gebrauch.

### "ECKEN "

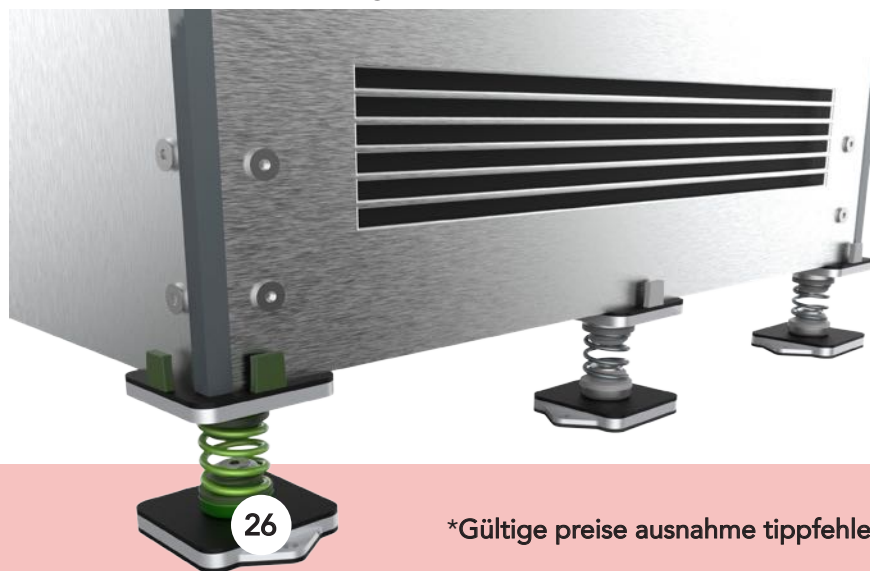

Hersteller von ANTIVIBRATIONSSYSTEME



## 2023

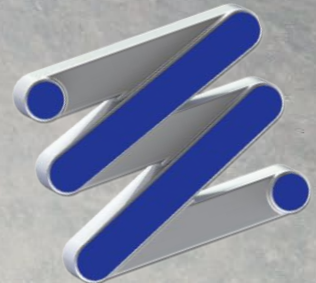
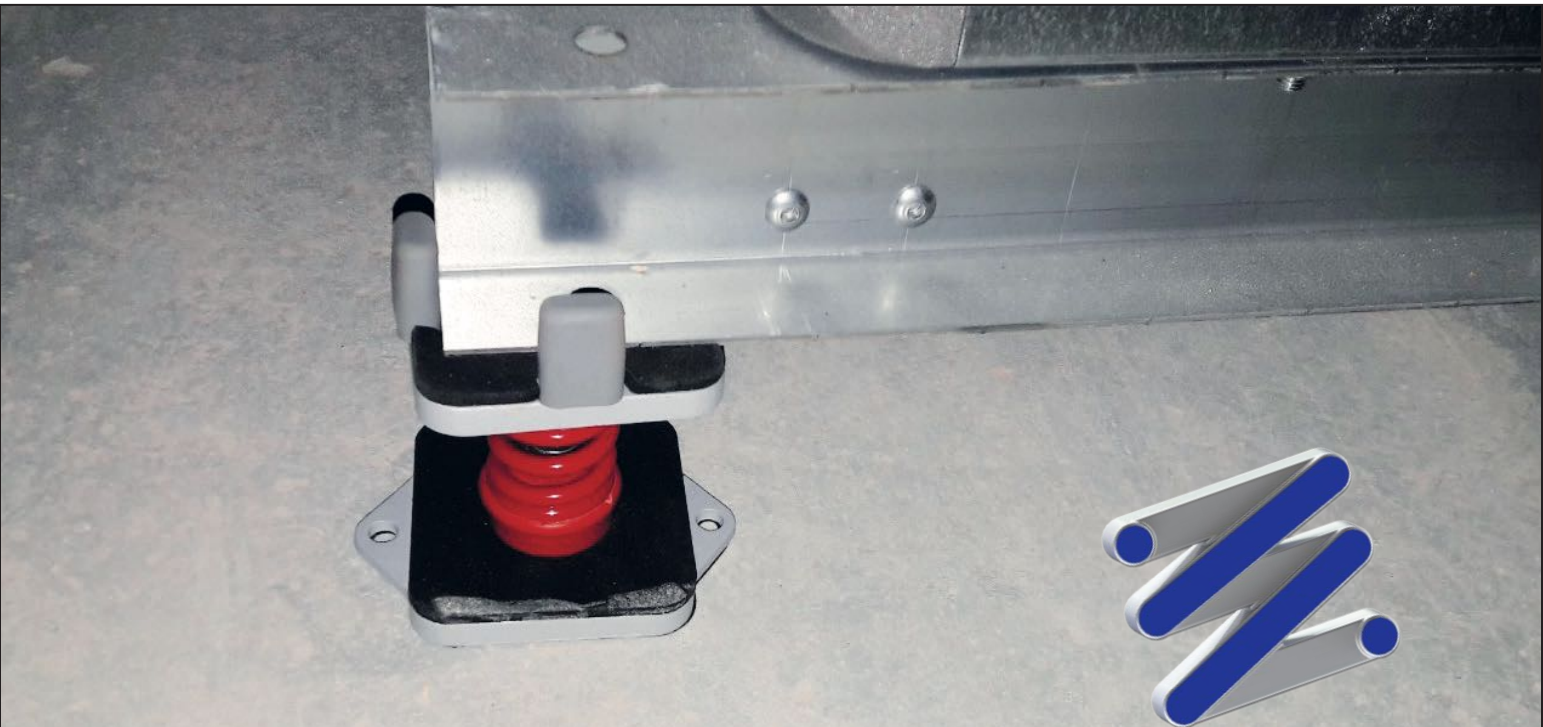



## MASCHINEN / SEMI-INDUSTRIELL ANTI-ROLL

Referenz	Belastung mín/máx	UVP €/St
Reference	minimum/maximum load	RRP €/Unit

### MASCHINEN BODEN / HYBRID

SE-TAV-4000/INOX 40 G	6 kg bis 40 kg	<b>Neu</b>	217,26 €
SE-TAV-4000/INOX 90 V	30 kg bis 90 kg	<b>Neu</b>	219,83 €
SE-TAV-4000/INOX 150 A	60 kg bis 150 kg	<b>Neu</b>	222,39 €
SE-TAV-4000/INOX 240 R	120 kg bis 240 kg	<b>Neu</b>	224,95 €
* Produkt erhältlich in verschiedenen metriken: 8, 10, 12, 14 & 16.			
SE-TAV-4000-E/INOX 40 G	6 kg bis 40 kg	<b>Neu</b>	222,39 €
SE-TAV-4000-E/INOX 90 V	30 kg bis 90 kg	<b>Neu</b>	224,95 €
SE-TAV-4000-E/INOX 150 A	60 kg bis 150 kg	<b>Neu</b>	227,50 €
SE-TAV-4000-E/INOX 240 R	120 kg bis 240 kg	<b>Neu</b>	230,06 €

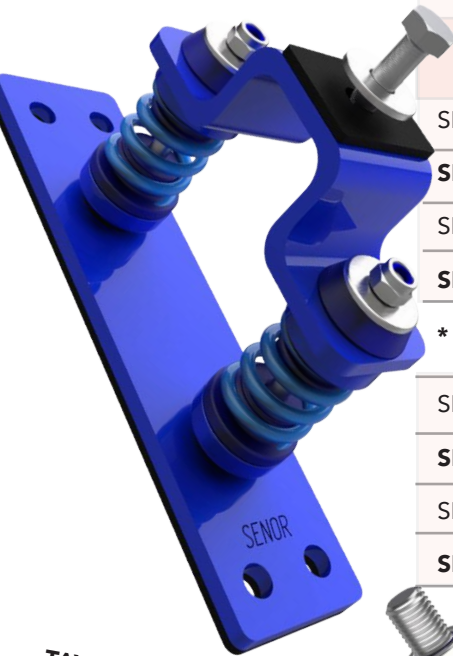

TAV-4000/INOX 150 A  
**Neu**



**Neu**

TAV-4000-E/INOX 240 R

Hersteller von **ANTIVIBRATIONSSYSTEME**

# Preisliste INDUSTRIE

## 2023

\*SENOR Antivibration System

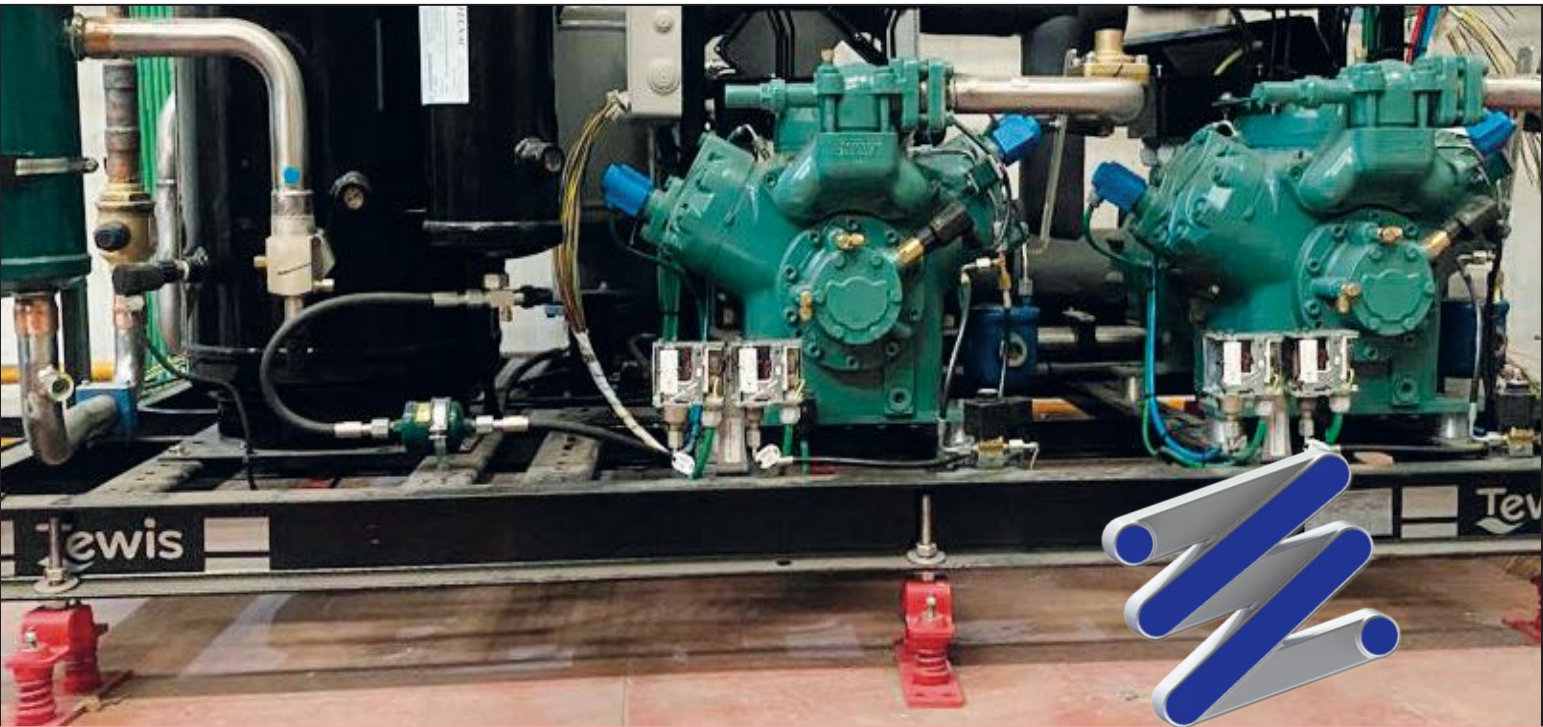

# SENOR



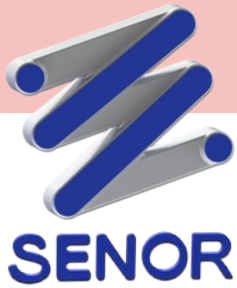

# Preisliste INDUSTRIE 2023

## MASCHINEN / INDUSTRIE ANTI-ROLL

Referenz	Belastung mín/máx	UVP €/St
Reference	minimum/maximum load	RRP €/Unit

### MASCHINEN BODEN / HYBRID

SE-TAV-8000/INOX 80 G	12 kg bis 80 kg	<b>Neu</b>	256,62 €
SE-TAV-8000/INOX 180 V	60 kg bis 180 kg	<b>Neu</b>	259,56 €
SE-TAV-8000/INOX 300 A	120 kg bis 300 kg	<b>Neu</b>	262,22 €
SE-TAV-8000/INOX 480 R	240 kg bis 480 kg	<b>Neu</b>	264,88 €

### MASCHINEN BODEN / HYBRID

SE-TAV-8000-E/INOX 80 G	12 kg bis 80 kg	<b>Neu</b>	263,02 €
SE-TAV-8000-E/INOX 180 V	60 kg bis 180 kg	<b>Neu</b>	265,97 €
SE-TAV-8000-E/INOX 300 A	120 kg bis 300 kg	<b>Neu</b>	268,61 €
SE-TAV-8000-E/INOX 480 R	240 kg bis 480 kg	<b>Neu</b>	271,28 €

Hersteller von **ANTIVIBRATIONSSYSTEME**

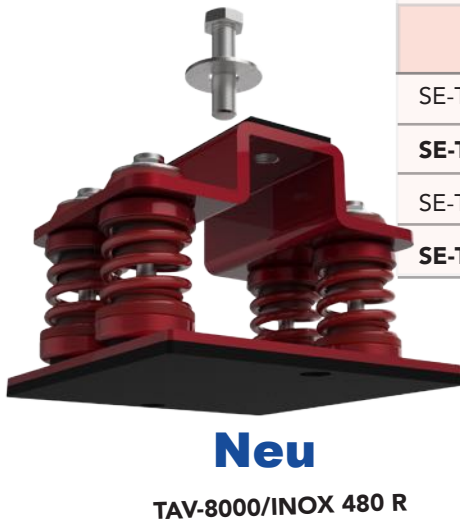



# Preisliste INDUSTRIE 2023

\*SENOR Antivibration System

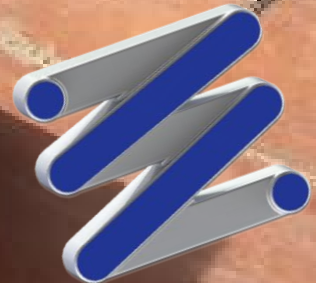

**SENOR**

## BODEN- AKUSTIK / STOLZEN GEGEN AUFPRALL

TS-80 A 280

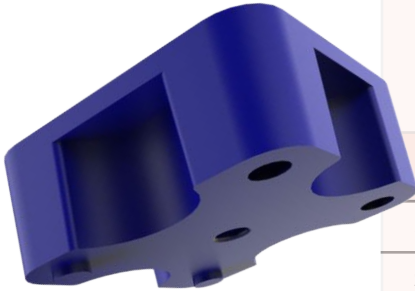

TS-60 R 400

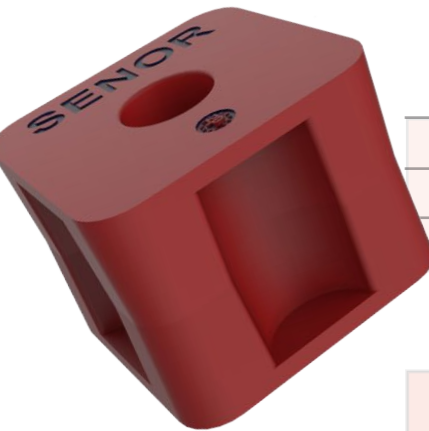

ACV-50/150 V

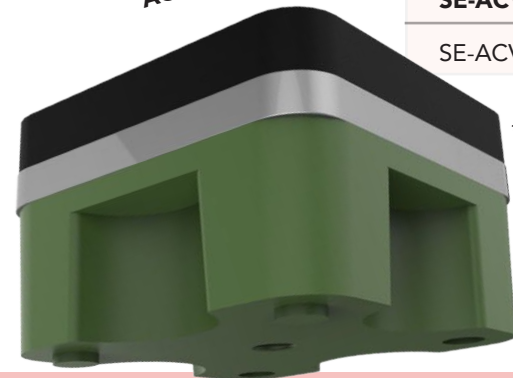

Referenz Reference	Belastung mín/máx minimum/maximum load	UVP €/St RRP €/Unit
<b>MODEL TS-80 / GUMMI</b>		
SE-TS-80 V 150/16-I	30 kg bis 150 kg	7,18 €
<b>SE-TS-80 A 280/16-I</b>	<b>140 kg bis 280 kg</b>	<b>7,61 €</b>
SE-TS-80 R 400/16-I	250 kg bis 400 kg	8,07 €

\* **Dimension:** 30 mm (höhe) x 80 mm (breite) x 80 mm (tiefe).

<b>MODEL TS-60 / GUMMI</b>		
SE-TS-60 V 150/25-I	30 kg bis 150 kg	15,42 €
<b>SE-TS-60 A 280/25-I</b>	<b>140 kg bis 280 kg</b>	<b>16,25 €</b>
SE-TS-60 R 400/25-I	250 kg bis 400 kg	17,11 €

\* **Dimension:** 60 mm (höhe) x 80 mm (breite) x 80 mm (tiefe).

<b>MODEL ACV-50 / GUMMI</b>		
SE-ACV-50/150 V/30-I	30 kg bis 150 kg	<b>Neu</b> 29,20 €
<b>SE-ACV-50/280 A/30-I</b>	<b>140 kg bis 280 kg</b>	<b>Neu</b> 29,58 €
SE-ACV-50/400 R/30-I	250 kg bis 400 kg	<b>Neu</b> 29,98 €

\* **Dimension:** 50 mm (höhe) x 80 mm (breite) x 80 mm (tiefe).

\* **Format Kiste: 16 Stk Mod.TS-80 (Mindestbestellung "Kiste")**

**25 Stk Mod.TS-60**

**30 Stk Mod.ACV-50**

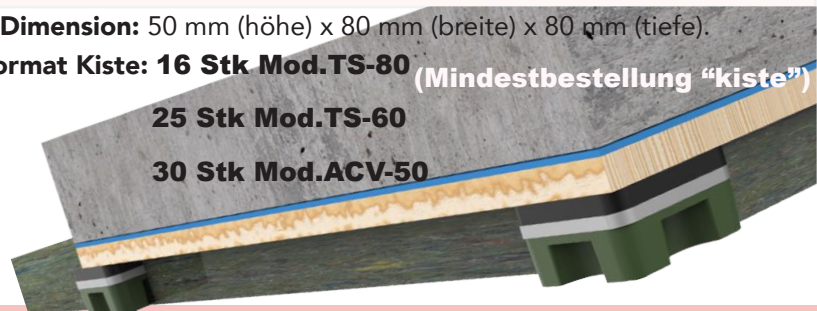

Hersteller von **ANTIVIBRATIONSSYSTEME**



## 2023

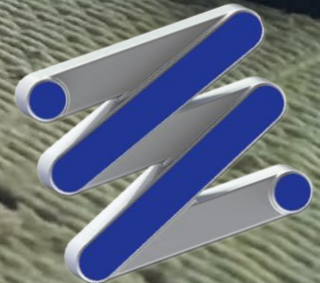

# SENOR

## MASCHINEN / SEMI-INDUSTRIELL

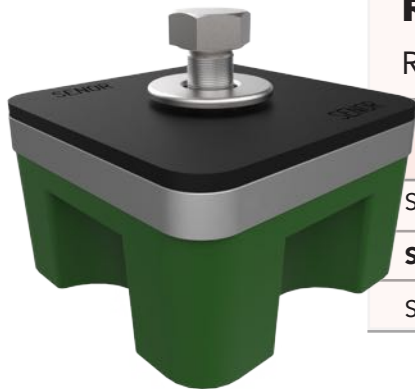

ACH-150/V



ACV-280/A



BI-400/R

Referenz Reference	Belastung mín/máx minimum/maximum load	UVP €/St RRP €/Unit
<b>SERIE MBS / GUMMI</b>		
SE-ACH-150 V	30 kg bis 150 kg	32,07 €
<b>SE-ACH-280 A</b>	<b>140 kg bis 280 kg</b>	<b>34,20 €</b>
SE-ACH-400 R	250 kg bis 400 kg	36,30 €
* <b>Dimension:</b> 42 mm (höhe) x 80 mm (breite) x 80 mm (tiefe).		
SE-ACV-150 V	30 kg bis 150 kg	33,07 €
<b>SE-ACV-280 A</b>	<b>140 kg bis 280 kg</b>	<b>35,24 €</b>
SE-ACV-400 R	250 kg bis 400 kg	37,44 €
* <b>Dimension:</b> 115 mm (höhe) x 80 mm (breite) x 80 mm (tiefe).		
SE-BI-150 V	30 kg bis 150 kg	38,92 €
<b>SE-BI-280 A</b>	<b>140 kg bis 280 kg</b>	<b>41,10 €</b>
SE-BI-400 R	250 kg bis 400 kg	43,31 €

\* **Dimension:**  
53 mm (höhe) x 80 mm  
(breite) x 112 mm (tiefe).

\* Produkte erhältlich in verschiedenen metriken: 8, 10, 12, 14, & 16

Hersteller von **ANTIVIBRATIONSSYSTEME**



# Preisliste INDUSTRIE

## 2023



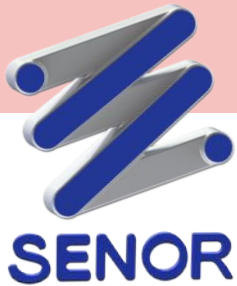

# Preisliste INDUSTRIE 2023

## MASCHINEN / SEMI-INDUSTRIELL



BI-400/R + PT 1

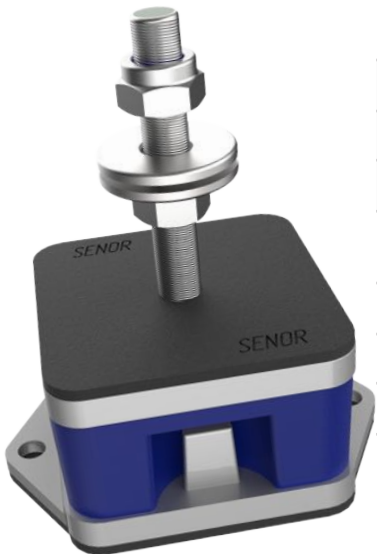

BIE-280/A

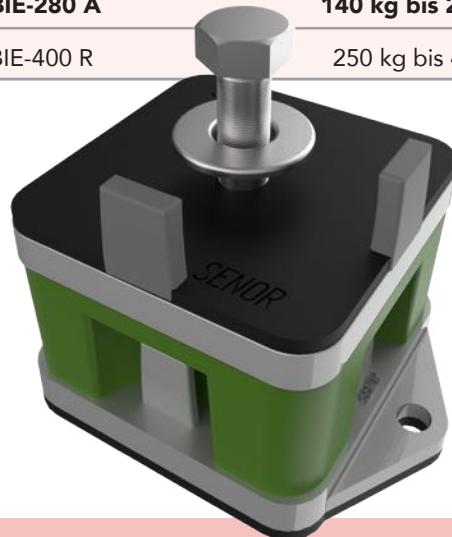

BI-150/V + PT 2

Referenz Reference	Belastung mín/máx minimum/maximum load	UVP €/St RRP €/Unit
<b>SERIE MBS / GUMMI</b>		
SE-BI-150 V + PT 1	30 kg bis 150 kg	49,98 €
<b>SE-BI-280 A + PT 1</b>	<b>140 kg bis 280 kg</b>	<b>52,14 €</b>
SE-BI-400 R + PT 1	250 kg bis 400 kg	54,37 €
* <b>Dimension:</b> 53 mm (höhe) x 80 mm (breite) x 112 mm (tiefe).		
SE-BI-150 V + PT 2	30 kg bis 150 kg	50,49 €
<b>SE-BI-280 A + PT 2</b>	<b>140 kg bis 280 kg</b>	<b>52,69 €</b>
SE-BI-400 R + PT 2	250 kg bis 400 kg	54,88 €
* <b>Dimension:</b> 53 mm (höhe) x 80 mm (breite) x 112 mm (tiefe).		
SE-BIE-150 V	30 kg bis 150 kg	42,80 €
<b>SE-BIE-280 A</b>	<b>140 kg bis 280 kg</b>	<b>44,99 €</b>
SE-BIE-400 R	250 kg bis 400 kg	47,23 €

\* Produkt erhältlich in verschiedenen metriken: 8, 10, 12, 14 & 16.

Hersteller von **ANTIVIBRATIONSSYSTEME**



# Preisliste INDUSTRIE 2023

\*SENOR Antivibration System

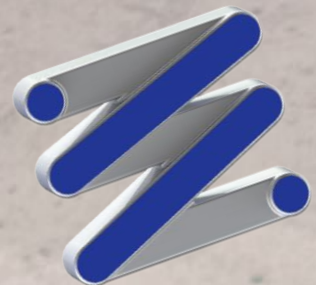
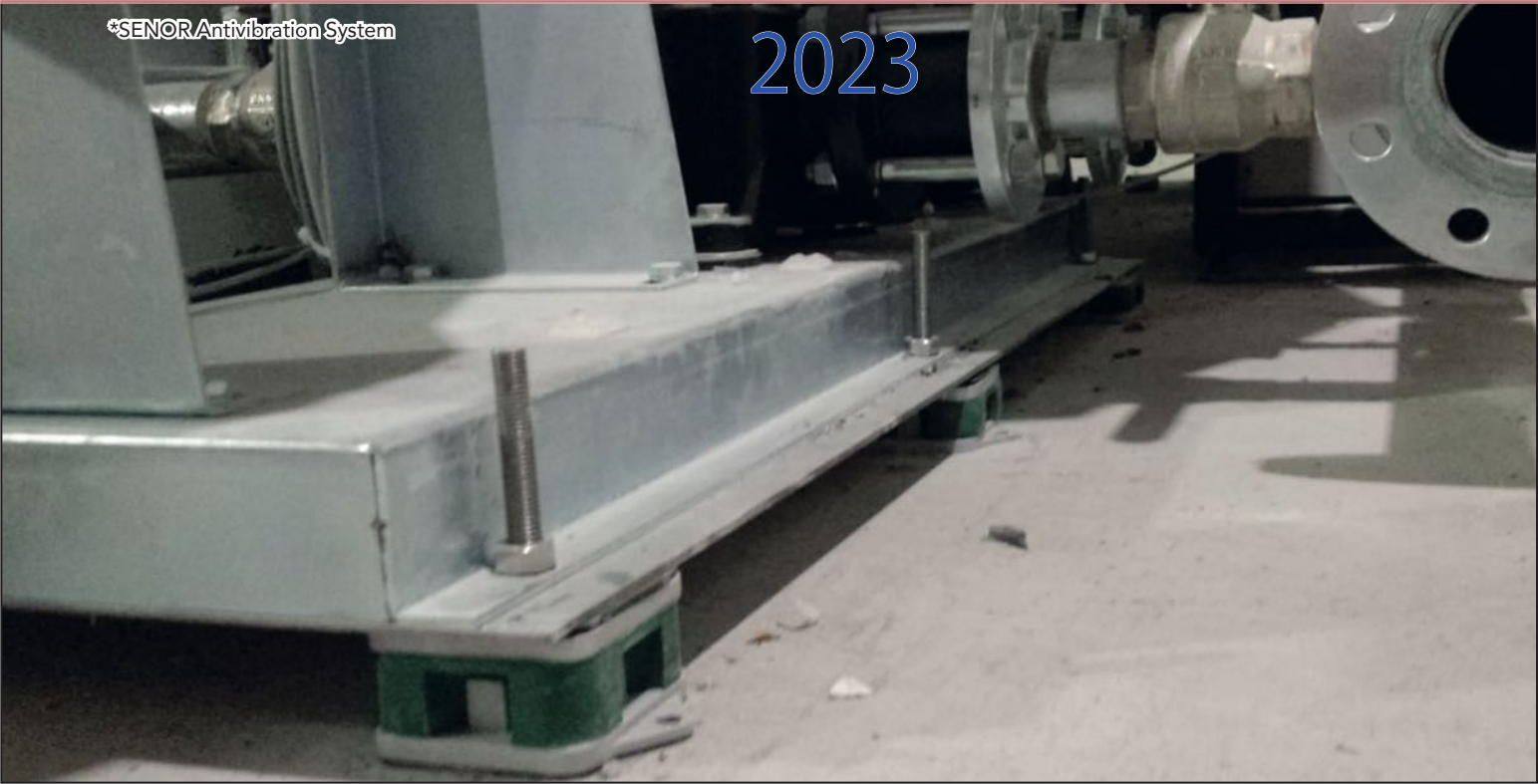

**SENOR**

## MASCHINEN / SEMI-INDUSTRIELL



BIR-150/V

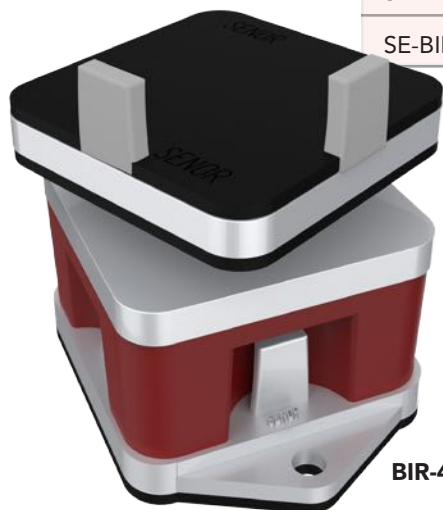

BIR-400/R + PT 2

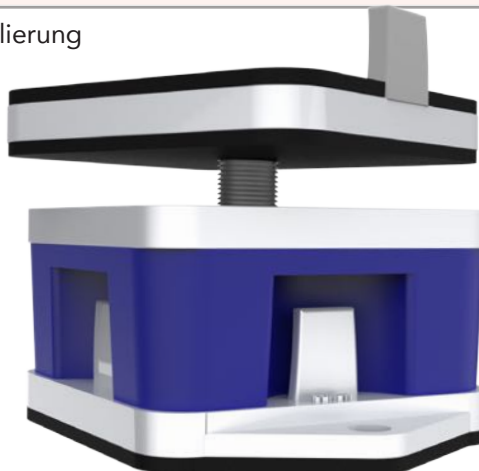

BIR-280/A + PT 1

Referenz Reference	Belastung mín/máx minimum/maximum load	UVP €/St RRP €/Unit
<b>SERIE MBS / GUMMI</b>		
SE-BIR-150 V	30 kg bis 150 kg	51,03 €
<b>SE-BIR-280 A</b>	<b>140 kg bis 280 kg</b>	<b>55,25 €</b>
SE-BIR-400 R	250 kg bis 400 kg	59,43 €
* Dimension: 95 mm (höhe) x 80 mm (breite) x 112 mm (tiefe).		
SE-BIR-150 V + PT 1	30 kg bis 150 kg	62,68 €
<b>SE-BIR-280 A + PT 1</b>	<b>140 kg bis 280 kg</b>	<b>66,90 €</b>
SE-BIR-400 R + PT 1	250 kg bis 400 kg	71,08 €
* Dimension: 95 mm (höhe) x 80 mm (breite) x 112 mm (tiefe).		
SE-BIR-150 V + PT 2	30 kg bis 150 kg	63,96 €
<b>SE-BIR-280 A + PT 2</b>	<b>140 kg bis 280 kg</b>	<b>68,17 €</b>
SE-BIR-400 R + PT 2	250 kg bis 400 kg	72,36 €

\* Produkte mit system- regulierung  
Bis zu 3 cm.

Hersteller von **ANTIVIBRATIONSSYSTEME**



## MASCHINEN BODEN / SEMI-INDUSTRIELL

Referenz Reference	Belastung mín/máx minimum/maximum load	UVP €/St RRP €/Unit
<b>SERIE MBS/GUMMI</b>		
SE-BIRE-150 V	30 kg bis 150 kg	54,91 €
<b>SE-BIRE-280 A</b>	<b>140 kg bis 280 kg</b>	<b>59,14 €</b>
SE-BIRE-400 R	250 kg bis 400 kg	63,32 €

\* **Dimension:** 115 mm (höhe) x 80 mm (breite) x 112 mm (tiefe).

\* **Produkt erhältlich in verschiedenen metriken:** 8, 10, 12, 14 & 16.



BIRE-280/A

## MASCHINEN / INDUSTRIE

### MASCHINEN BODEN / GUMMI

#### Serie BI/THREE

SE-BI/THREE-450 V	90 kg bis 450 kg	<b>Neu</b>	432,14 €
<b>SE-BI/THREE-840 A</b>	<b>420 kg bis 840 kg</b>	<b>Neu</b>	<b>435,33 €</b>
SE-BI/THREE-1200 R	750 kg bis 1200 kg	<b>Neu</b>	438,40 €

**Neu**

BI/THREE-450 V

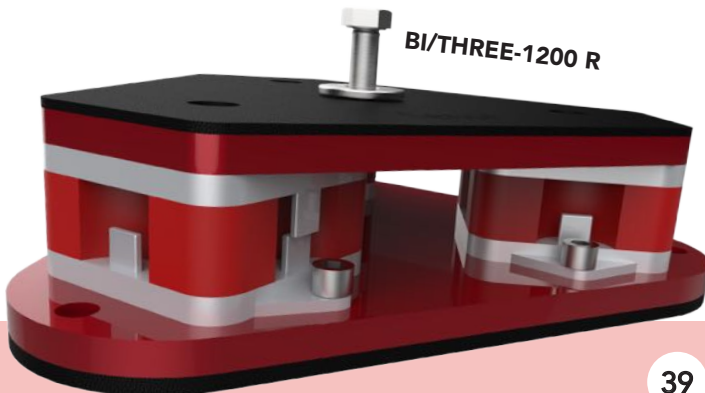

## MASCHINEN / INDUSTRIE



**Neu**

BI/THREE-840 EA

Referenz Reference	Belastung mín/máx minimum/maximum load	UVP €/St RRP €/Unit
<b>MASCHINEN BODEN / GUMMI</b>		
Serie BI/THREE		
SE-BI/THREE-450 EV	90 kg bis 450 kg	<b>Neu</b> 444,93 €
<b>SE-BI/THREE-840 EA</b>	<b>420 kg bis 840 kg</b>	<b>Neu</b> 448,13 €
SE-BI/THREE-1200 ER	750 kg bis 1200 kg	<b>Neu</b> 451,20 €

\* **Produkt erhältlich in verschiedenen metriken** : 8, 10, 12, 14 & 16.

## MASCHINEN / INDUSTRIE

### MASCHINEN BODEN / HYBRID

#### Serie BM80/INOX

**BM-80/IX 80 G**



SE-BM-80/IX 80 G	20 kg bis 80 kg	100,61 €
<b>SE-BM-80/IX 120 V</b>	<b>50 kg bis 120 kg</b>	<b>101,88 €</b>
SE-BM-80/IX 160 A	75 kg bis 160 kg	103,10 €
<b>SE-BM-80/IX 200 R</b>	<b>90 kg bis 200 kg</b>	<b>104,36 €</b>

\* **Dimension:**

- 70 mm (höhe)
- 80 mm (breite)
- 112 mm (tiefe)



**BM-80/IX 200 R**

Hersteller von **ANTIVIBRATIONSSYSTEME**



2023

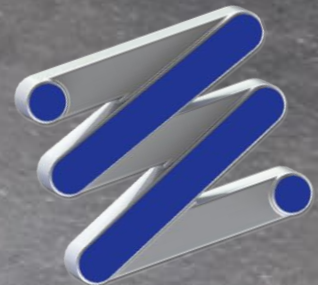

# SENOR

## MASCHINEN / INDUSTRIE

Referenz	Belastung mín/máx	UVP €/St
Reference	minimum/maximum load	RRP €/Unit

## MASCHINEN BODEN / HYBRID

### Serie BM-80/INOX

SE-BM-80/IX EG 80	20 kg bis 80 kg	104,49 €
<b>SE-BM-80/IX EV 120</b>	<b>50 kg bis 120 kg</b>	<b>105,75 €</b>
SE-BM-80/IX EA 160	75 kg bis 160 kg	107,00 €
<b>SE-BM-80/IX ER 200</b>	<b>90 kg bis 200 kg</b>	<b>108,26 €</b>
SE-BM-80/IX REG 80	20 kg bis 80 kg	118,61 €
<b>SE-BM-80/IX REV 120</b>	<b>50 kg bis 120 kg</b>	<b>119,91 €</b>
SE-BM-80/IX REA 160	75 kg bis 160 kg	121,11 €
<b>SE-BM-80/IX RER 200</b>	<b>90 kg bis 200 kg</b>	<b>122,37 €</b>
<b>* Produkt erhältlich in verschiedenen metriken: 8, 10, 12, 14 &amp; 16.</b>		
SE-BM-80/IX RG 80	20 kg bis 80 kg	114,77 €
<b>SE-BM-80/IX RV 120</b>	<b>50 kg bis 120 kg</b>	<b>116,00 €</b>
SE-BM-80/IX RA 160	75 kg bis 160 kg	117,25 €
<b>SE-BM-80/IX RR 200</b>	<b>90 kg bis 200 kg</b>	<b>118,49 €</b>

\* Produkt mit  
nivelierungs-system



BM-80/INOX EV 120

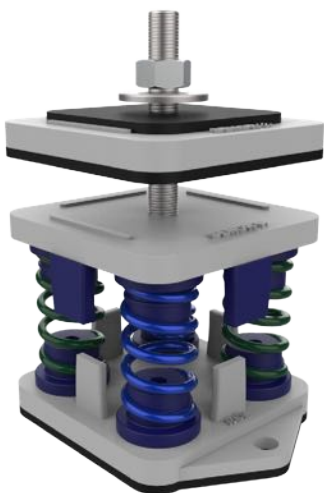

BM-80/INOX REA 160



BM-80/INOX RR 200

Hersteller von **ANTIVIBRATIONSSYSTEME**



\*SENOR Antivibration System

## 2023



# SENOR

## MASCHINEN / INDUSTRIE

BM-80/IX RG 80 + PT 1

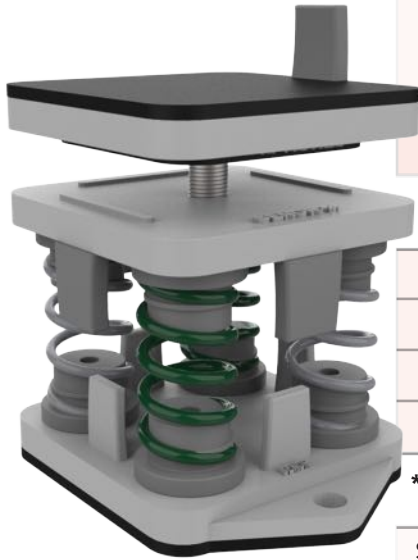

Referenz	Belastung mín/máx	UVP €/St
Reference	minimum/maximum load	RRP €/Unit

## MASCHINEN BODEN / HYBRID

### Serie BM80/INOX

SE-BM-80/IX RG 80 + PT 1	20 kg bis 80 kg	<b>Neu</b>	126,40 €
<b>SE-BM-80/IX RV 120 + PT 1</b>	<b>50 kg bis 120 kg</b>	<b>Neu</b>	<b>127,64 €</b>
SE-BM-80/IX RA 160 + PT 1	75 kg bis 160 kg	<b>Neu</b>	128,91 €
<b>SE-BM-80/IX RR 200 + PT 1</b>	<b>90 kg bis 200 kg</b>	<b>Neu</b>	<b>130,15 €</b>

\* **Produkt erhältlich in verschiedenen metriken:** 12, 14 & 16.

SE-BM-80/IX RG 80 + PT 2	20 kg bis 80 kg	<b>Neu</b>	127,67 €
<b>SE-BM-80/IX RV 120 + PT 2</b>	<b>50 kg bis 120 kg</b>	<b>Neu</b>	<b>128,92 €</b>
SE-BM-80/IX RA 160 + PT 2	75 kg bis 160 kg	<b>Neu</b>	130,19 €
<b>SE-BM-80/IX RR 200 + PT 2</b>	<b>90 kg bis 200 kg</b>	<b>Neu</b>	<b>131,42 €</b>

\* Produkt mit nivellierung system.

**Neu**

BM-80/IX RV 120 + PT 2



Hersteller von **ANTIVIBRATIONSSYSTEME**



### MASCHINEN / INDUSTRIE

Referenz	Belastung mín/máx	UVP €/St
Reference	minimum/maximum load	RRP €/Unit

### MASCHINEN BODEN / HYBRID

#### Serie BM100/INOX

SE-BM-100/IX 150 G	40 kg bis 150 kg	130,43 €
<b>SE-BM-100/IX 250 V</b>	<b>120 kg bis 250 kg</b>	<b>131,72 €</b>
SE-BM-100/IX 330 A	200 kg bis 330 kg	135,46 €
<b>SE-BM-100/IX 500 R</b>	<b>280 kg bis 500 kg</b>	<b>136,75 €</b>
SE-BM-100/IX EG 150	40 kg bis 150 kg	134,34 €
<b>SE-BM-100/IX EV 250</b>	<b>120 kg bis 250 kg</b>	<b>135,76 €</b>
SE-BM-100/IX EA 330	200 kg bis 330 kg	139,39 €
<b>SE-BM-100/IX ER 500</b>	<b>280 kg bis 500 kg</b>	<b>140,63 €</b>

\* **Produkt erhältlich in verschiedenen metriken: 8, 10, 12, 14 & 16.**

SE-BM-100/IX REG 150	40 kg bis 150 kg	148,46 €
<b>SE-BM-100/IX REV 250</b>	<b>120 kg bis 250 kg</b>	<b>149,70 €</b>
SE-BM-100/IX REA 330	200 kg bis 330 kg	153,47 €
<b>SE-BM-100/IX RER 500</b>	<b>280 kg bis 500 kg</b>	<b>154,75 €</b>



BM-100/INOX 500 R

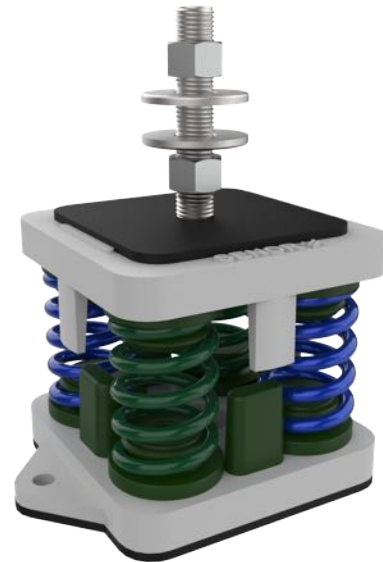

BM-100/INOX EV 250

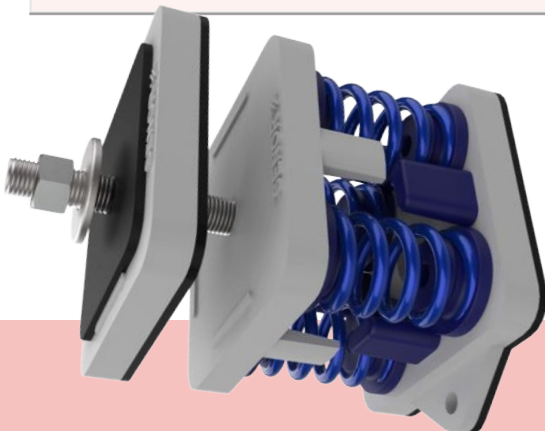

BM-100/INOX REA 330

\* Produkt mit nivellierung system.

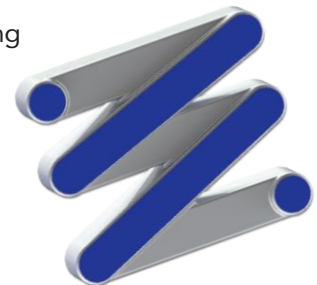

# Preisliste INDUSTRIE 2023

## MASCHINEN / INDUSTRIE

Referenz	Belastung mín/máx	UVP €/St
Reference	minimum/maximum load	RRP €/Unit

## MASCHINEN BODEN / HYBRID

### Serie BM100/INOX

SE-BM-100/IX RG 150	40 kg bis 150 kg		144,56 €
<b>SE-BM-100/IX RV 250</b>	<b>120 kg bis 250 kg</b>		<b>145,83 €</b>
SE-BM-100/IX RA 330	200 kg bis 330 kg		149,60 €
<b>SE-BM-100/IX RR 500</b>	<b>280 kg bis 500 kg</b>		<b>150,85 €</b>
SE-BM-100/IX RG 150 + PT 1	40 kg bis 150 kg	<b>Neu</b>	156,22 €
<b>SE-BM-100/IX RV 250 + PT 1</b>	<b>120 kg bis 250 kg</b>	<b>Neu</b>	<b>157,49 €</b>
SE-BM-100/IX RA 330 + PT 1	200 kg bis 330 kg	<b>Neu</b>	161,24 €
<b>SE-BM-100/IX RR 500 + PT 1</b>	<b>280 kg bis 500 kg</b>	<b>Neu</b>	<b>162,49 €</b>



BM-100/INOX RR 500

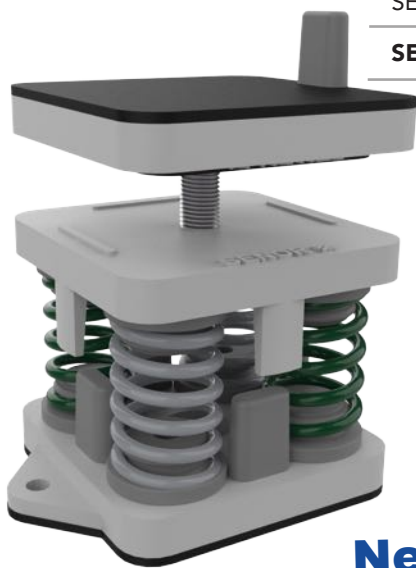

**Neu**

BM-100/INOX RG 150 + PT 1

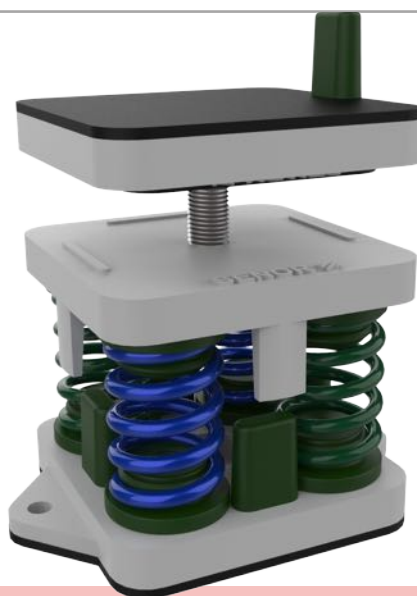

**Neu**

BM-100/INOX RV 250 + PT 1

\* Mit  
Nivellierungssystem.

Hersteller von **ANTIVIBRATIONSSYSTEME**



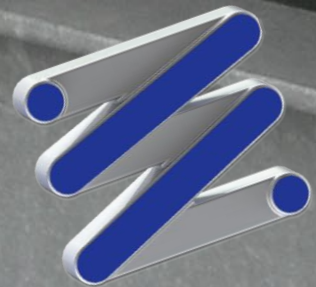
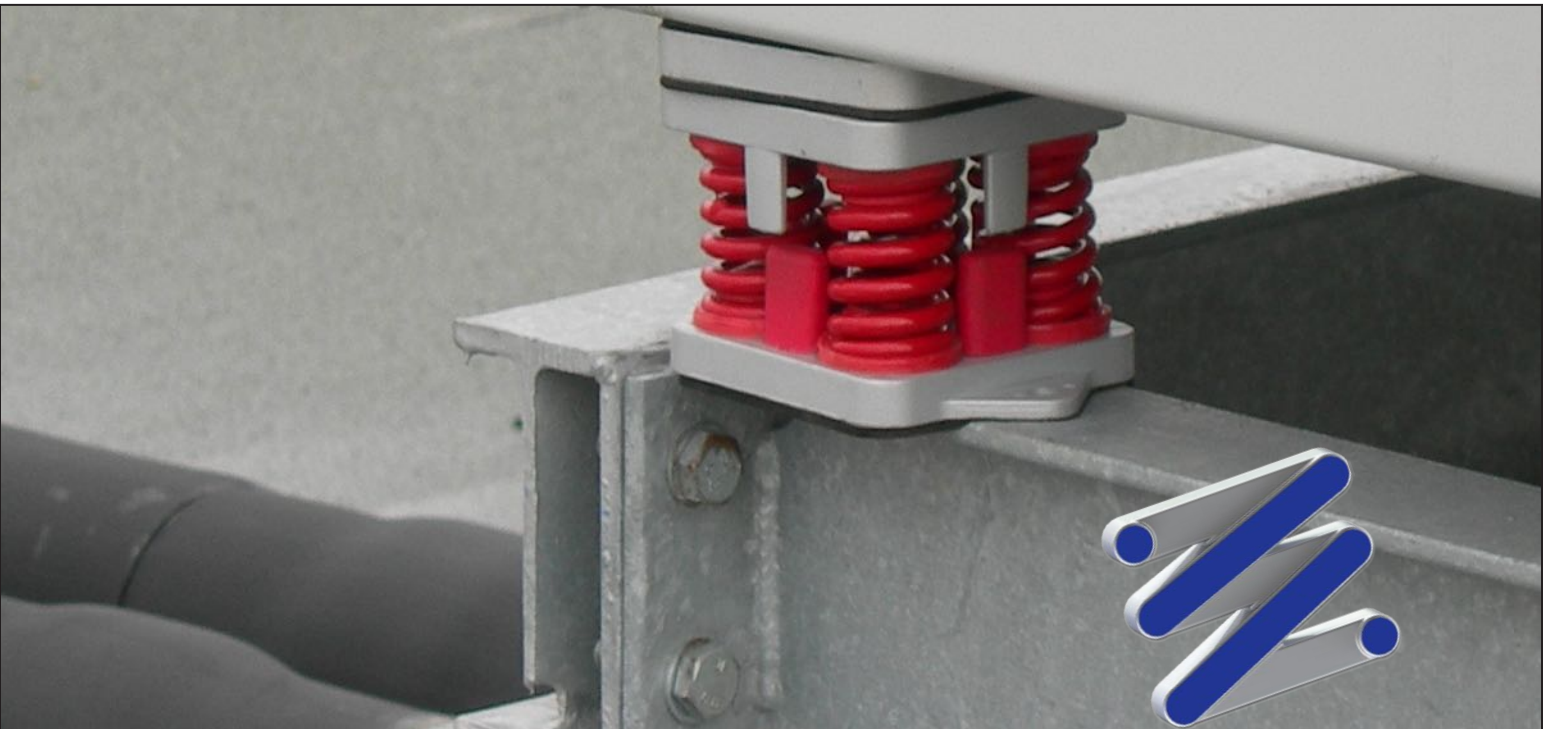



# Preisliste INDUSTRIE 2023



**Neu**  
BM-100/INOX RA 330 + PT 2

## MASCHINEN / INDUSTRIE

Referenz	Belastung mín/máx	UVP €/St
Reference	minimum/maximum load	RRP €/Unit

## MASCHINEN BODEN / HYBRID

### Serie BM100/INOX

SE-BM-100/IX RG 150 + PT 2	40 kg bis 150 kg	<b>Neu</b>	157,50 €
SE-BM-100/IX RV 250 + PT 2	120 kg bis 250 kg	<b>Neu</b>	158,76 €
SE-BM-100/IX RA 330 + PT 2	200 kg bis 330 kg	<b>Neu</b>	162,51 €
SE-BM-100/IX RR 500 + PT 2	280 kg bis 500 kg	<b>Neu</b>	163,77 €

\* Produkte mit Nivellierungs-system.

\* **Produkt erhältlich in verschiedenen metriken:** 12, 14 & 16.

## MASCHINEN BODEN / HYBRID ANTI-ROLL

### Serie BMF-100/ANTV

SE-BMF-100 G 150 ANTV	40 kg bis 150 kg	<b>Neu</b>	264,84 €
SE-BMF-100 V 250 ANTV	120 kg bis 250 kg	<b>Neu</b>	266,09 €
SE-BMF-100 A 330 ANTV	200 kg bis 330 kg	<b>Neu</b>	267,36 €
SE-BMF-100 R 500 ANTV	280 kg bis 500 kg	<b>Neu</b>	268,61 €

**Neu**  
BMF-100 R 500 ANTV

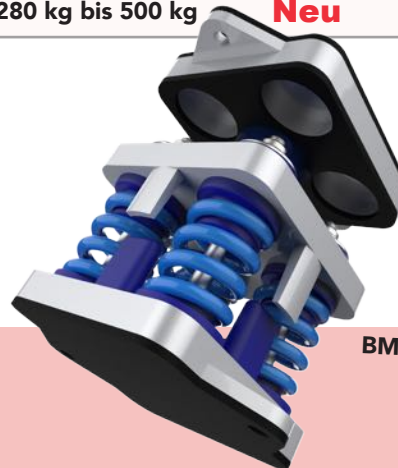

**Neu**  
BMF-100 A 330 ANTV

Hersteller von **ANTIVIBRATIONSSYSTEME**



## 2023



# SENOR



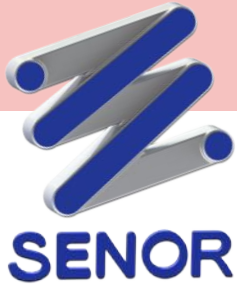

# Preisliste INDUSTRIE 2023

## MASCHINEN / INDUSTRIE MIT GROSSER TONNAGE

Referenz	Belastung mín/máx	UVP €/St
Reference	minimum/maximum load	RRP €/Unit

## MASCHINEN BODEN / HYBRID ANTI-ROLL

### Serie BMF/SHOCK ABSORBER

SE-BMF-SAI/300 G	150 kg bis 300 kg	<b>Neu</b>	1277,19 €
<b>SE-BMF-SAI/675 V</b>	<b>280 kg bis 675 kg</b>	<b>Neu</b>	<b>1285,31 €</b>
SE-BMF-SAI/1125 A	600 kg bis 1125 kg	<b>Neu</b>	1472,40 €
SE-BMF-SAI/1800 R	975 kg bis 1800 kg	<b>Neu</b>	1496,83 €

\* Produkt erhältlich in verschiedenen metriken: 12, 14,16,18 & 20.

**Neu**  
BMF-SAI/675 V



**Neu**  
BMF-SAI/1125 A

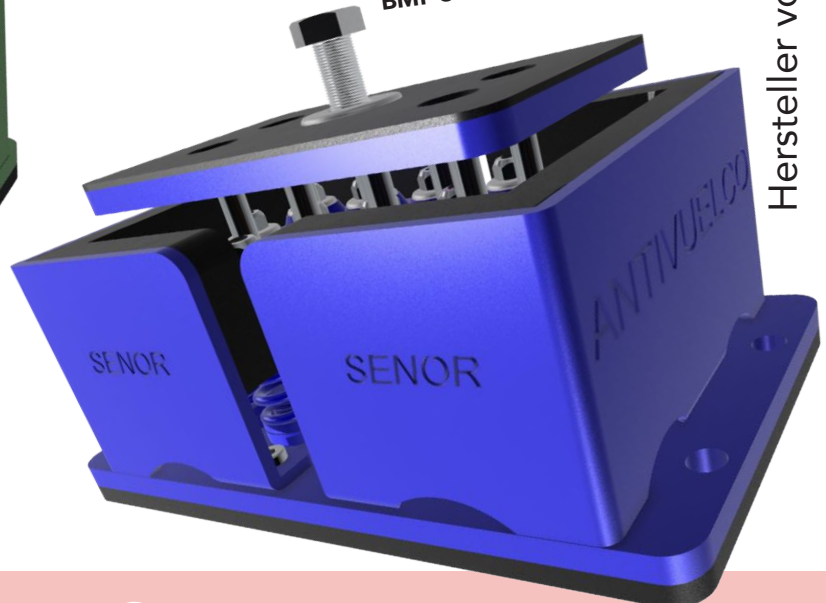

Hersteller von **ANTIVIBRATIONSSYSTEME**

\*SENOR Antivibration System

## 2023





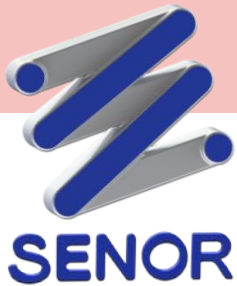

# Preisliste INDUSTRIE 2023

## MASCHINEN / INDUSTRIE MIT GROSSER TONNAGE

Referenz	Belastung mín/máx	UVP €/St
Reference	minimum/maximum load	RRP €/Unit

### MASCHINEN BODEN / HYBRID

#### Serie SAB/SHOCK ABSORBER

SE-SAB-3 G	120 kg bis 450 kg	695,42 €
<b>SE-SAB-3 V</b>	<b>360 kg bis 750 kg</b>	<b>710,71 €</b>
SE-SAB-3 A	600 kg bis 990 kg	724,33 €
<b>SE-SAB-3 R</b>	<b>840 kg bis 1500 kg</b>	<b>739,64 €</b>
SE-SAB-4 G	160 kg bis 600 kg	828,04 €
<b>SE-SAB-4 V</b>	<b>480 kg bis 1000 kg</b>	<b>843,33 €</b>
SE-SAB-4 A	800 kg bis 1320 kg	858,62 €
<b>SE-SAB-4 R</b>	<b>1120 kg bis 2000 kg</b>	<b>872,25 €</b>
SE-SAB-5 G	200 kg bis 750 kg	1127,27 €
<b>SE-SAB-5 V</b>	<b>600 kg bis 1250 kg</b>	<b>1140,86 €</b>
SE-SAB-5 A	1000 kg bis 1650 kg	1154,47 €
<b>SE-SAB-5 R</b>	<b>1400 kg bis 2500 kg</b>	<b>1169,74 €</b>

**\*Produkte erhältlich in verschiedene metriken:**

12,14,16,18 & 20.

Hersteller von **ANTIVIBRATIONSSYSTEME**



SAB-3 R

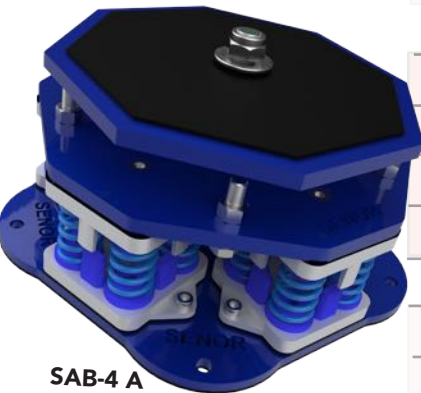

SAB-4 A

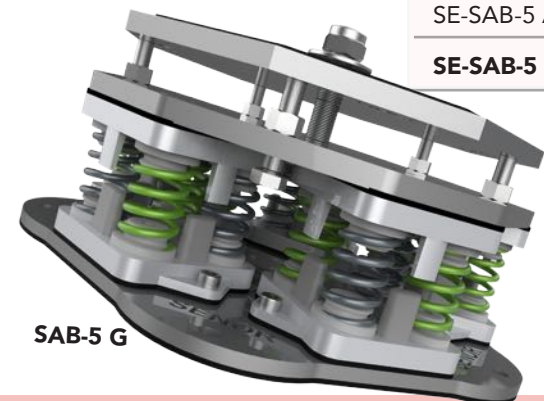

SAB-5 G



### MASCHINEN / **INDUSTRIE MIT GROSSER TONNAGE**

\* Verarbeitung gegen vibrationen in einer **KÜHL ETAGE**. Alle produkte können hergestellt werden entsprechen der typologie des Strukturprofils je erforderlich.

(Profilel rohrförmig, Betonträger **IP, IPN, HEA, HEB**, etc...).

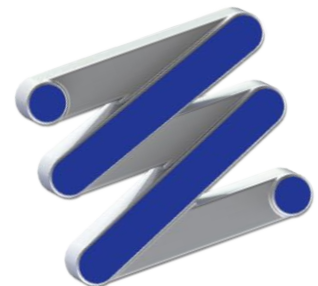

# SENOR



# Preisliste INDUSTRIE 2023

## MASCHINEN / INDUSTRIE MIT GROSSER TONNAGE

Referenz	Belastung mín/máx	UVP €/St
Reference	minimum/maximum load	RRP €/Unit

## MASCHINEN BODEN / HYBRID ANTI-ROLL

### Serie EIGHT-TBF/ANTV

SE-EIGHT-TBF 160 G	60 kg bis 160 kg	261,21 €
<b>SE-EIGHT-TBF 360 V</b>	<b>125 kg bis 360 kg</b>	<b>264,55 €</b>
SE-EIGHT-TBF 600 A	285 kg bis 600 kg	268,20 €
SE-EIGHT-TBF 1000 R	525 kg bis 1000 kg	292,09 €

\*Produkte erhältlich in verschiedenen metriken: 12,14,16,18 & 20.

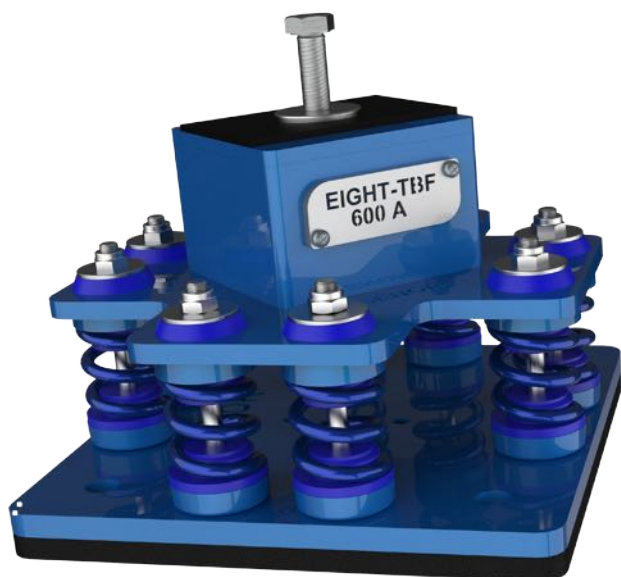
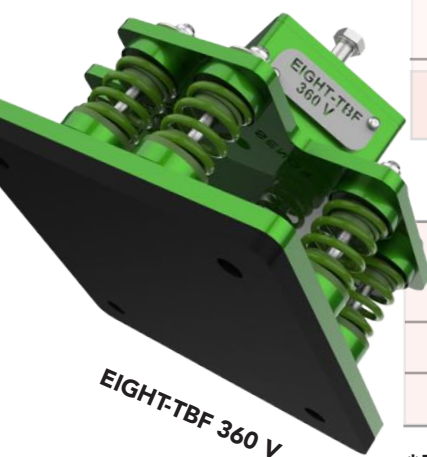

EIGHT-TBF 600 A



Hersteller von **ANTIVIBRATIONSSYSTEME**

# Preisliste INDUSTRIE 2023

\*SENOR Antivibration System

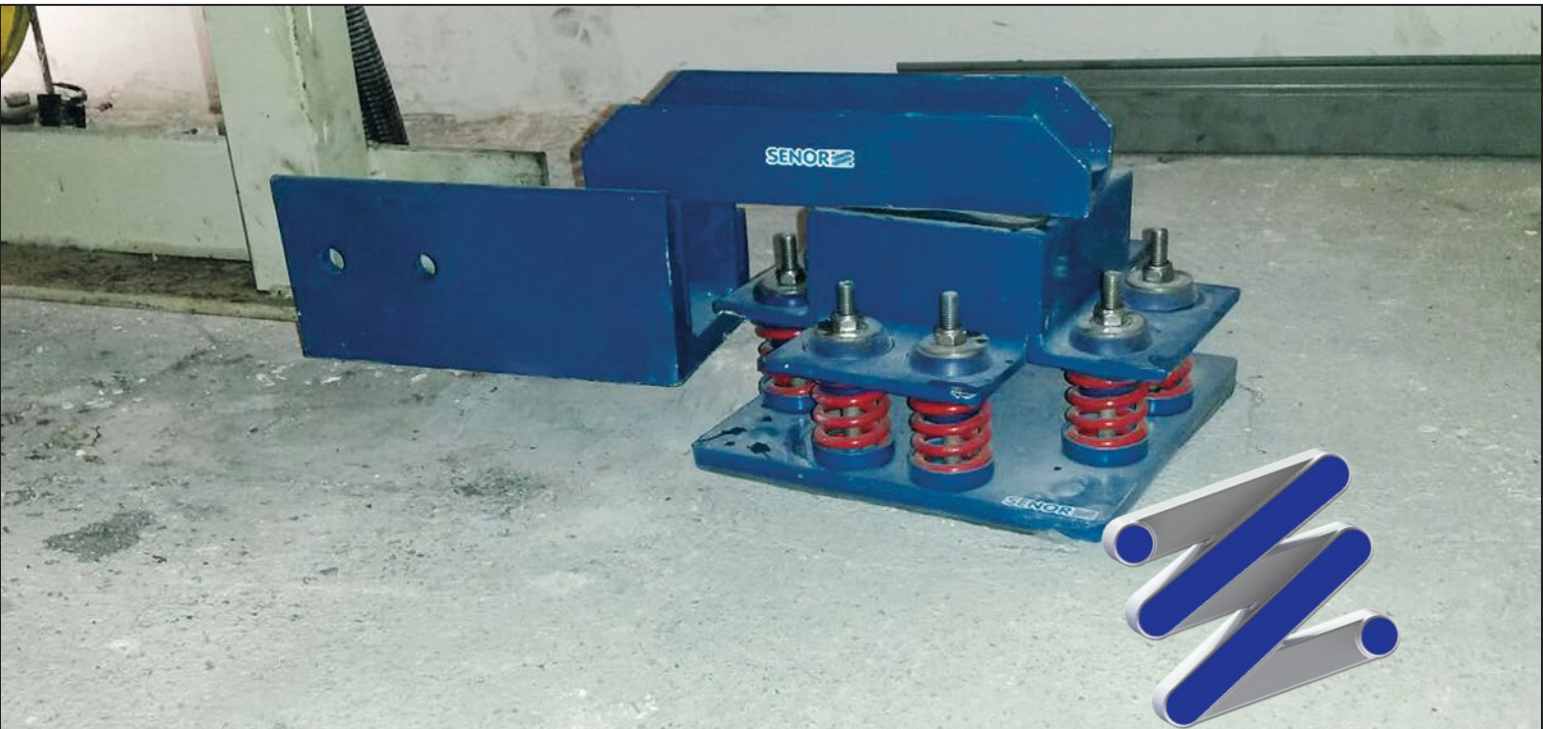



## MASCHINEN / INDUSTRIE MIT GROSSER TONNAGE

Referenz	Belastung mín/máx	UVP €/St
Reference	minimum/maximum load	RRP €/Unit

### MASCHINEN BODEN / HYBRID ANTI-ROLL

#### Serie TEN-TBF/ANTV

SE-TEN-TBF 1200 R	680 kg bis 1200 kg	<b>Neu</b>	312,91 €
<b>SE-TEN-TBF 1400 R</b>	<b>800 kg bis 1400 kg</b>	<b>Neu</b>	<b>393,87 €</b>
SE-TEN-TBF 1600 R	950 kg bis 1600 kg	<b>Neu</b>	472,53 €

\* **Produkt erhältlich in verschiedenen metriken:** 12,14,16,18 & 20.

TEN-TBF 1400 R



TEN-TBF 1600 R



Hersteller von **ANTIVIBRATIONSSYSTEME**

\*SENOR Antivibration System

2023



# SENOR



## MASCHINEN / INDUSTRIE MIT GROSSER TONNAGE

Referenz	Belastung mín/máx	UVP €/St
Reference	minimum/maximum load	RRP €/Unit

### MASCHINEN BODEN / HYBRID ANTI-ROLL

Serie 2x TEN-TBF/ANTV

SE-2x EIGHT-TBF 1000 R	1050 kg bis 2000 kg	<b>Neu</b>	660,96 €
SE-2x TEN-TBF 1200 R	1360 kg bis 2400 kg	<b>Neu</b>	702,60 €
SE-2x TEN-TBF 1400 R	1600 kg bis 2800 kg	<b>Neu</b>	864,51 €
SE-2x TEN-TBF 1600 R	1900 kg bis 3200 kg	<b>Neu</b>	1021,85 €



Hersteller von **ANTIVIBRATIONSSYSTEME**

# Preisliste INDUSTRIE 2023

\*SENOR Antivibration System





## ANKER-PLATTE ÜBER MAUER / **AKUSTIK**

Referenz	Belastung mín/máx	UVP €/St
Reference	minimum/maximum load	RRP €/Unit
<b>METALL-STRUKTUR / ANTI-ROLL</b>		

PLM VERTIKAL-500 A-HEA  
**Neu**

### Serie PLM VERTIKAL

SE-PLM VERTICAL-200 V-TB	50 kg bis 200 kg	<b>Neu</b>	326,83 €
<b>SE-PLM VERTICAL-500 A-TB</b>	<b>200 kg bis 500 kg</b>	<b>Neu</b>	<b>353,47 €</b>
SE-PLM VERTICAL-800 R-HEA	400 kg bis 800 kg	<b>Neu</b>	487,53 €
<b>SE-PLM VERTICAL 1200 R</b>	<b>750 kg bis 1200 kg</b>	<b>Neu</b>	<b>569,22 €</b>
SE-PLM VERTICAL 1600 R-HEB	1100 kg bis 1600 kg	<b>Neu</b>	665,41 €

\* Alle produkte können hergestellt werden je nach Tipologie und Strukturprofil . (Profilel rohrförmigr, Betonträger **IP, IPN, HEA, HEB**, etc.)

Hersteller von **ANTIVIBRATIONSSYSTEME**

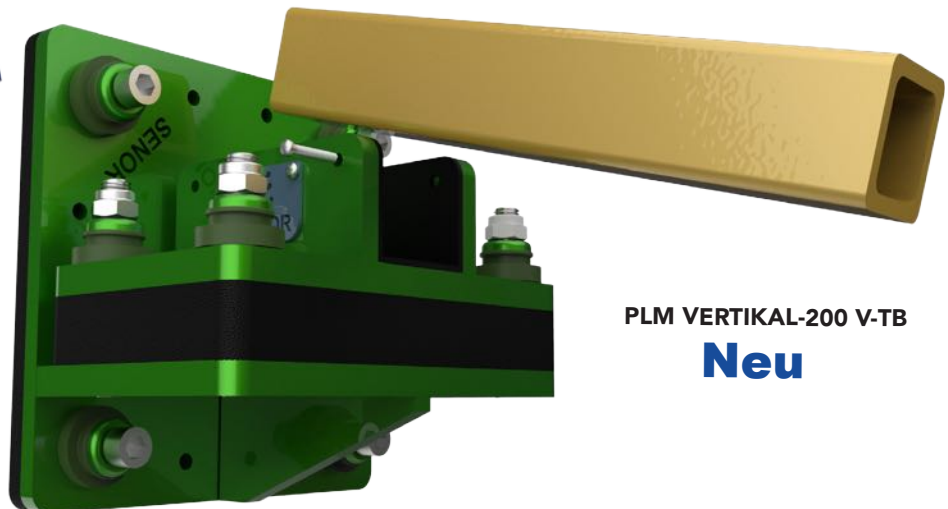
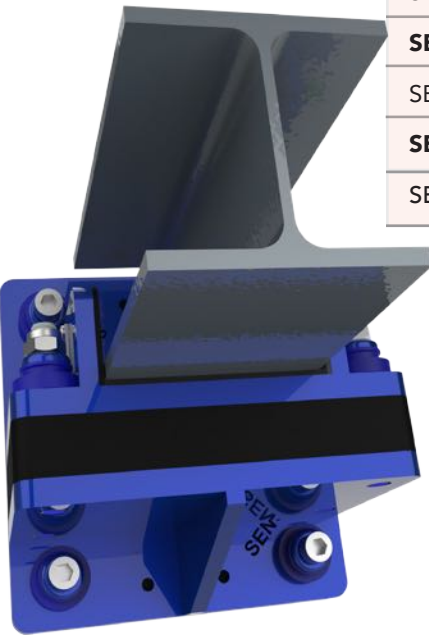

PLM VERTIKAL-200 V-TB  
**Neu**

# Preisliste INDUSTRIE 2023

\*SENOR Antivibration System



**SENOR**



## PLATTE ZUM ANKERN , BODEN / **AKUSTIK**

<b>Referenz</b>	<b>Belastung mín/máx</b>	<b>UVP €/St</b>
Reference	minimum/maximum load	RRP €/Unit
<b>METALL-STRUKTUR / ANTI-ROLL</b>		

### Serie PLM Boden

SE-PLM/PSC-120 V-TUBULAR	50 kg bis 120 kg	<b>Neu</b>	211,65 €
SE-PLM/PSC-150 A TUBULAR	80 kg bis 150 kg	<b>Neu</b>	218,04 €
SE-PLM/PSC-180 R-TUBULAR	100 kg bis 180 kg	<b>Neu</b>	224,63 €
SE-PLM/PST-400 V-TUBULAR	150 kg bis 400 kg	<b>Neu</b>	231,02 €
SE-PLM/PST-600 A-TUBULAR	300 kg bis 600 kg	<b>Neu</b>	282,22 €
SE-PLM/PST-800 R-TUBULAR	500 kg bis 800 kg	<b>Neu</b>	359,53 €

**Neu**  
PLM/PSC-120 V-TUBULAR

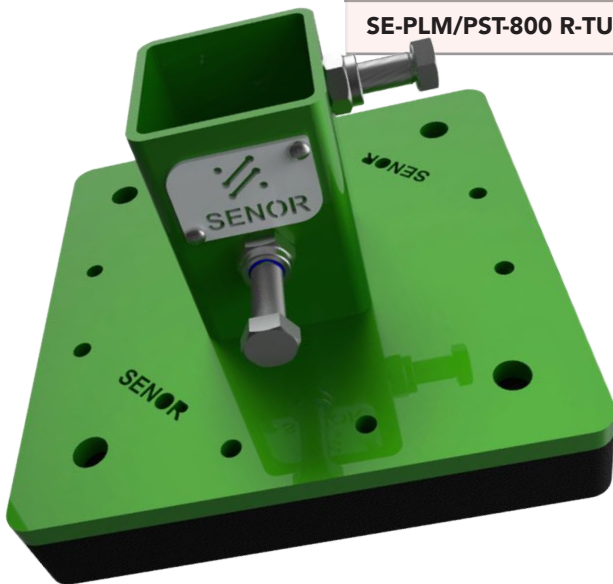

**Neu**  
PLM/PST-800 R-TUBULAR

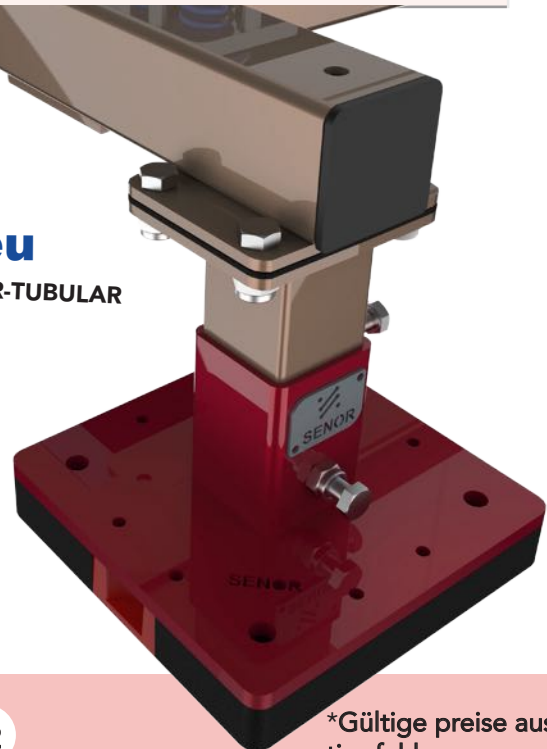

\* Alle produkte können hergestellt werden je nach Tipologie und Strukturprofil (Profile rohrförmig, **betonträger IP, IPN, HEA, HEB**, etc.)

Hersteller von **ANTIVIBRATIONSSYSTEME**

# Preisliste INDUSTRIE

## 2023

\*SENOR Antivibration System

### PLATTEN ZUM ANKERN , BODEN / **AKUSTIK**

<b>Referenz</b>	<b>Belastung mín/máx</b>	<b>UVP €/St</b>
Reference	minimum/maximum load	RRP €/Unit

### **METALL - STRUKTUR / ANTI-ROLL**

#### Serie PLM Boden

SE-PLM/PST 1200 R TUBULAR	700 kg bis 1200 kg	<b>Neu</b>	414,36 €
<b>SE-PLM/PST 1600 R TUBULAR</b>	<b>1000 kg bis 1600 kg</b>	<b>Neu</b>	<b>487,95 €</b>
SE-PLM/PST 2000 R TUBULAR	1500 kg bis 2000 kg	<b>Neu</b>	589,97 €
<b>SE-PLM/PST 3200 R TUBULAR</b>	<b>2600 kg bis 3200 kg</b>	<b>Neu</b>	<b>816,20 €</b>

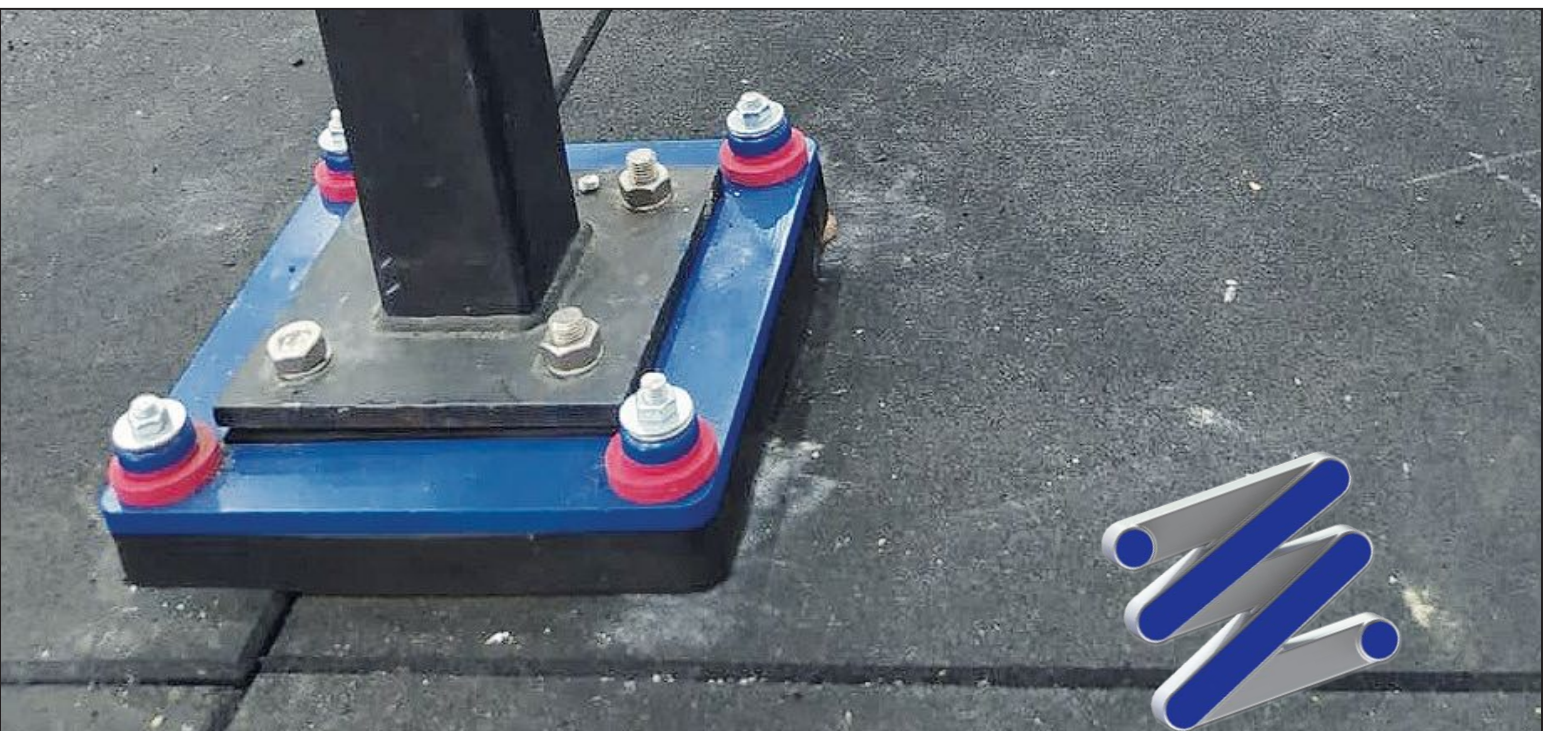



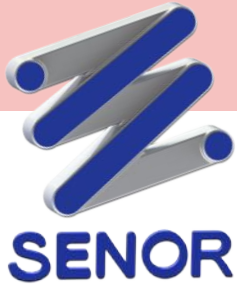

# Preisliste INDUSTRIE 2023

PLATTE ZUM ANKERN ÜBER BODEN MIT TELESKOP SYSTEM

Referenz	Belastung mínima/máx	UVP €/St
Reference	minimum/maximum load	RRP €/Unit

## METALL- STRUKTUR / ANTI-ROLL

### Serie PLM/PST

SE-PLM/PST 400 V-TELESCÓPICO	150 kg bis 400 kg	<b>Neu</b>	395,95 €
SE-PLM/PST 600 A-TELESCÓPICO	300 kg bis 600 kg	<b>Neu</b>	407,15 €
SE-PLM/PST 800 R-TELESCÓPICO	500 kg bis 800 kg	<b>Neu</b>	429,90 €

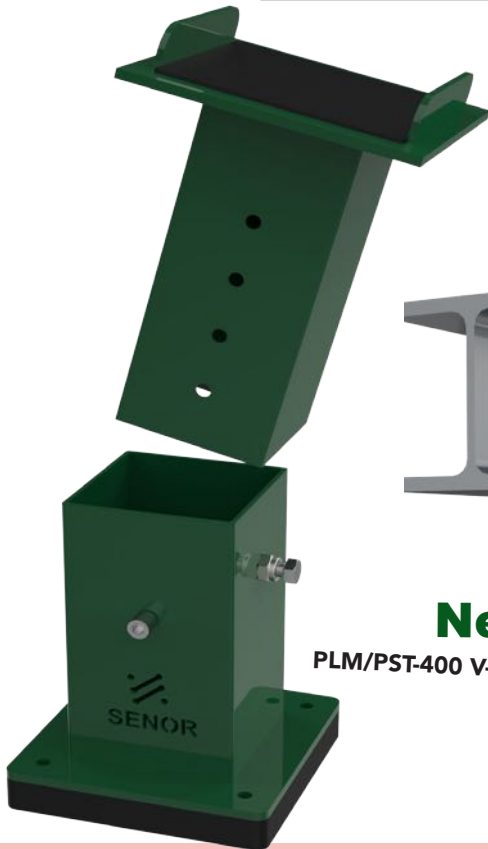

**Neu**  
PLM/PST-400 V-TELESCÓPICO



**Neu**  
PLM/PST-600 A-TELESCÓPICO

**Neu**  
SE-PLM/PST 800 R-TELESCÓPICO



Hersteller von **ANTIVIBRATIONSSYSTEME**

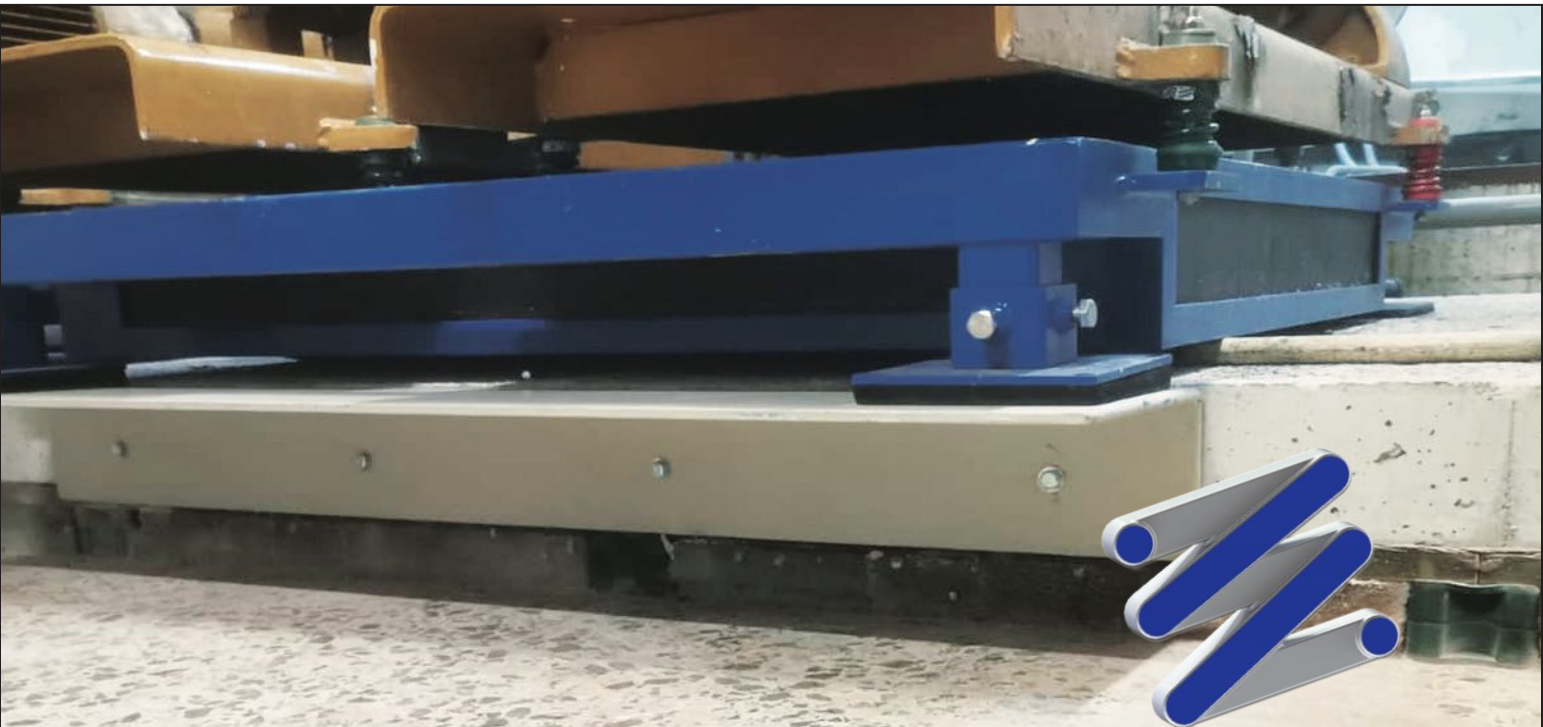



## PLATTE ZUM ANKERN FÜR MAUER / **AKUSTIK**

FTV-40 G + B.A/L800

**Neu**



Referenz	Belastung mín/máx	UVP €/St
Reference	minimum/maximum load	RRP €/Unit

## **AUFZUG, ROHRLEITUN, ETC / ANTI-ROLL**

### Serie FTV MAUER

SE-FTV-40 G + B.A/L-800	8 kg bis 40 kg	<b>Neu</b>	246,38 €
<b>SE-FTV-90 V + B.A/L800</b>	<b>30 kg bis 90 kg</b>	<b>Neu</b>	<b>249,58 €</b>
SE-FTV-150 A + B.A/L-800	50 kg bis 150 kg	<b>Neu</b>	252,78 €
<b>SE-FTV-240 R + B.A/L800</b>	<b>130 kg bis 240 kg</b>	<b>Neu</b>	<b>255,98 €</b>
SE-FTV-80 G + B.A/L-800	16 kg bis 80 kg	<b>Neu</b>	513,30 €
<b>SE-FTV-180 V + B.A/L800</b>	<b>60 kg bis 180 kg</b>	<b>Neu</b>	<b>516,51 €</b>
SE-FTV-300 A + B.A/L-800	100 kg bis 300 kg	<b>Neu</b>	519,69 €
<b>SE-FTV-480 R + B.A/L800</b>	<b>260 kg bis 480 kg</b>	<b>Neu</b>	<b>522,90 €</b>

FTV-480 R + B.A/L800

**Neu**



\*Gültige preise  
ausnahme tippfehlern.

Hersteller von **ANTIVIBRATIONSSYSTEME**



### PLATTE ZUM ANKERN FÜR MAUER / **AKUSTIK**

\* Alle produkte können hergestellt und angepasst werden je nach  
Typologie und gebrauch. (Profile **rohrförmig**, **betonträger IP**,  
**IPN**, **HEA**, **HEB**, **ROHRLEITUNG**, **AUFZUG**, etc.)

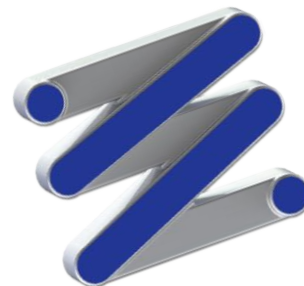

# SENOR



## PLATTE ZUM ANKERN MAUER / **AKUSTIK**



Hersteller von **ANTIVIBRATIONSSYSTEME**

\*Raum **TRANSFORMATOR**. Akustische trennung von Cabelleitungen und Hochspannung von maschinen durch die Trennwand zwischen Wohnungen.



### Serie **FTV WAND**

\* **LASTENAUFZUG.** Trennakustik zwischen struktur und Wohnungen.

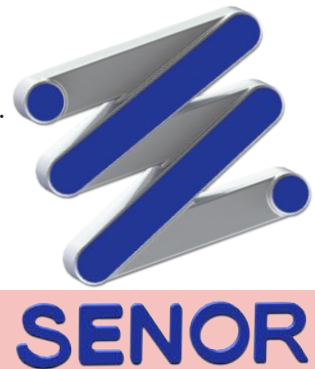



## GESTELL AIR / **AKUSTIK**

<b>Referenz</b>	<b>Belastung mín/máx</b>	<b>UVP €/St</b>
Reference	minimum/maximum load	RRP €/Unit

### **ABSAUGER, KÜHLGERÄTE & KLIMAAANLAGEN**

**GESTELL** Entworfen um die enrgie und vibrier mechanik zu beenden und den schall zu reduzieren

<b>SE-GESTELL AIR/1000x1000</b>	<b>Federungen inlegend</b>	<b>Neu</b>	<b>2553,27 €</b>
---------------------------------	----------------------------	------------	------------------

GESTELL AIR  
**Neu**

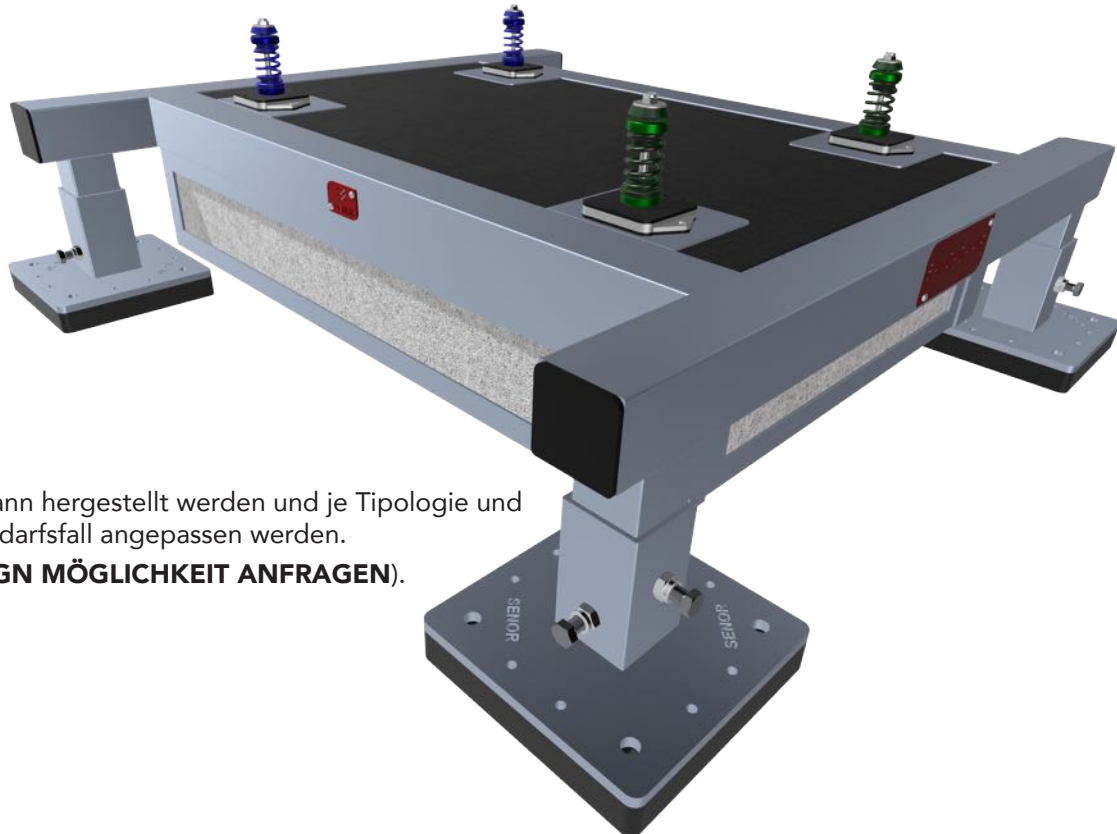

Hersteller von **ANTIVIBRATIONSSYSTEME**

\***GESTELL AIR** kann hergestellt werden und je Tipologie und Bedarfsfall angepasst werden.  
( **DESIGN MÖGLICHKEIT ANFRAGEN**).

# Preisliste INDUSTRIE

## 2023

\*SENOR Antivibration System



GESTELL AIR / **AKUSTIK**





## GESTELL BCP / AKUSTIK

Referenz	Belastung mín/máx	UVP €/St
Reference	minimum/maximum load	RRP €/Unit

### AUFZUG, ABSAUGER, KÜHLGERÄTE & KLIMAANLAGEN

**GESTELL** Selbstnivellierung entworfen um alle negative energie vibro-mechanik zu beseitigen und den schall von den maschinen zu verringern.

SE-GESTELL BCP/1000x1000	Federungen inliegend	<b>Neu</b>	3519,54 €
--------------------------	----------------------	------------	-----------



**Neu**

\*GESTELL BCP

Kann hergestellt werden und je Tipologie und bedarfsfall angepasst werden.

Hersteller von **ANTIVIBRATIONSSYSTEME**

### GESTELL BCP / **AKUSTIK**

Referenz	Belastung mín/máx	UVP €/St
Reference	minimum/maximum load	RRP €/Unit

### **AUFZUG, ABSAUGER, KÜHLGERÄTE & KLIMAAANLAGEN**

**ZUBEHÖR** Für die herstellung von beton-platten selbstnivellierend.  
Erlaubt alle federungen von den MODELLEN BM-100/INOX.

SE-Hülse BCP/100	Federungen NICHT inliegend	<b>Neu</b> 319,86 €
------------------	----------------------------	---------------------

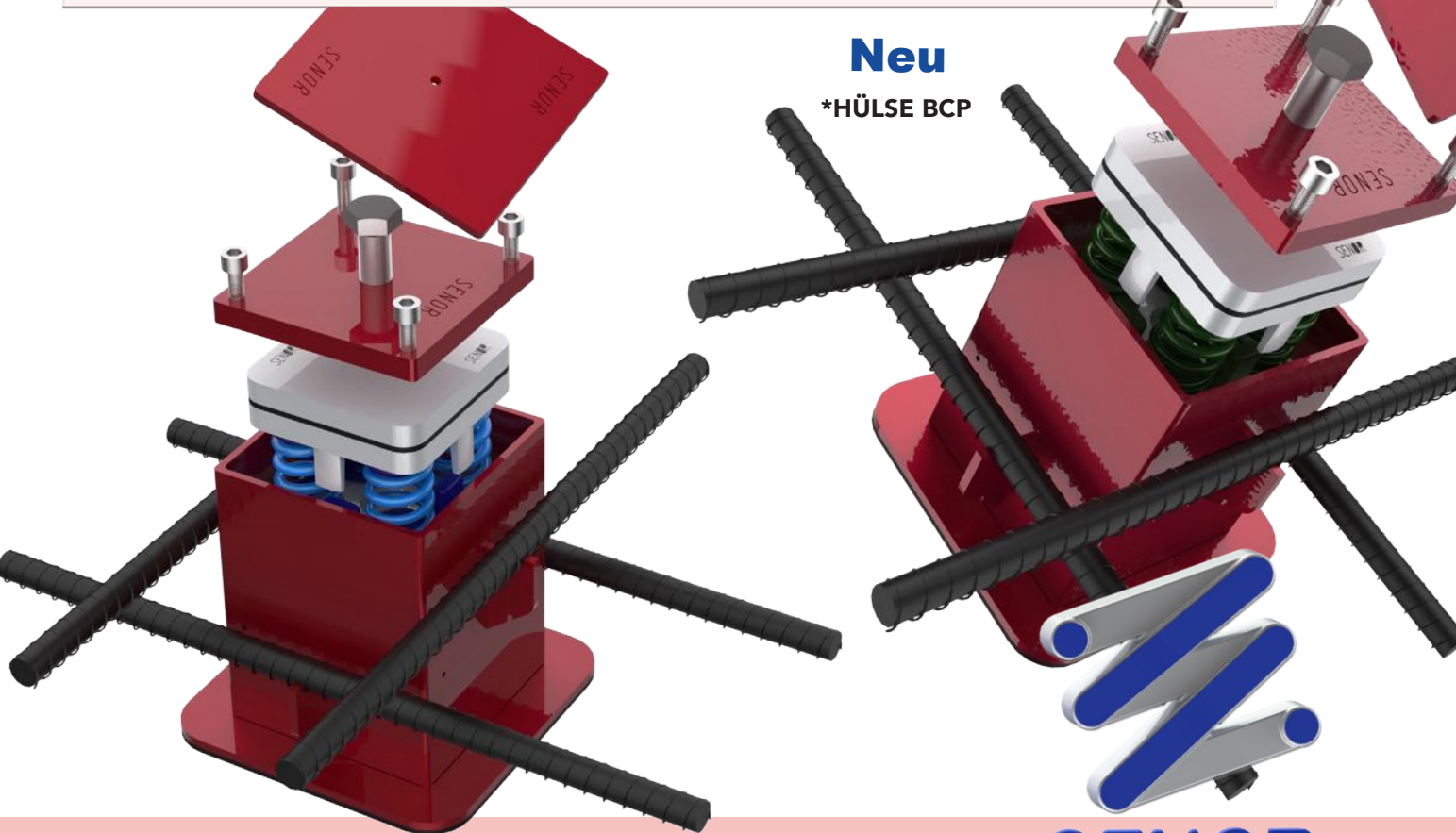

**Neu**  
\*HÜLSE BCP



## GESTELL BCP / **AKUSTIK**



Hersteller von **ANTIVIBRATIONSSYSTEME**

### **Neu** GESTELL **BCP AKUSTIK**

\* Maschinen für die Klimatisierung in **CARREFOUR CÁDIZ**.



**Neu**  
PLATTE  
**BCP AKUSTIK**

\* **AUFZUG.** Akustische trennung zwischen den kleinwänden die die Fahrausrüstung halten .

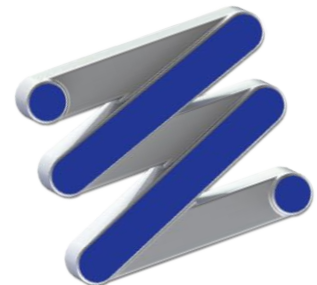

**SENOR**



## BODEN - PLATTE / AKUSTIK

Referenz	Belastung mín/máx	UVP €/St
Reference	minimum/maximum load	RRP €/Unit
<b>ABSAUGER, KÜHLGERÄTE &amp; KLIMAAANLAGEN</b>		
<p><b>PFT-1000/ADAPTA</b> entworfen um sicherheit und leistung beizubringen. Aber der hauptzweck ist die beendung von aller mechanischen vibration .</p>		
SE-PFT-1000/ADAPTA 450 V	100 kg bis 450 kg	<b>Neu</b> 493,84 €
SE-PFT-1000/ADAPTA 800 A	350 kg bis 800 kg	<b>Neu</b> 495,64 €
SE-PFT-1000/ADAPTA 1400 R	800 kg bis 1400 kg	<b>Neu</b> 497,42 €

Hersteller von **ANTIVIBRATIONSSYSTEME**

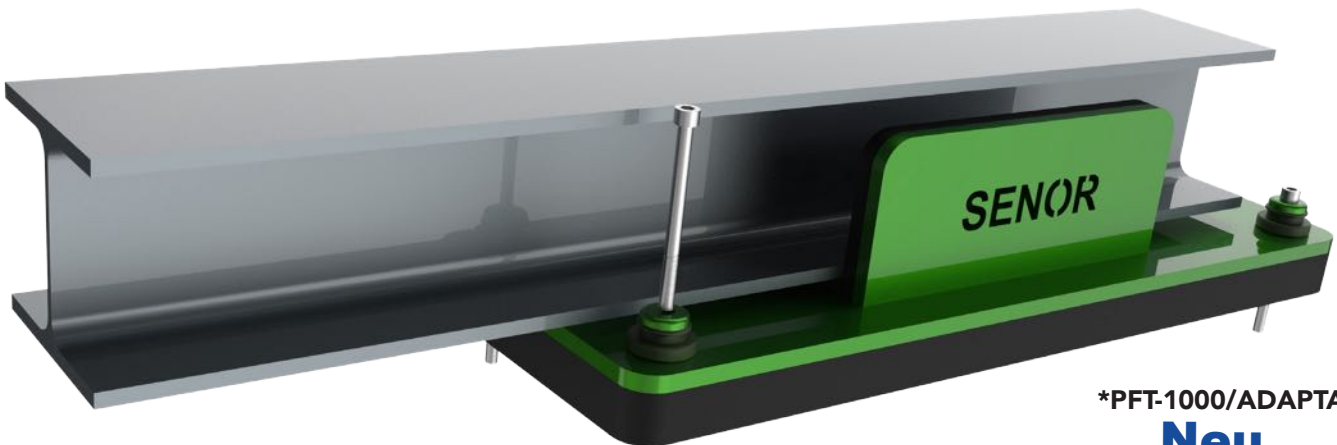

**Neu**

**\*PFT-1000/ADAPTA**

“Könnte hergestellt werden je Tipologie und Bedarfsfall des Kunden.  
(**DESIGN MÖGLICHKEIT ANFRAGEN**).

**\*PFT-1000/ADAPTA  
Neu**

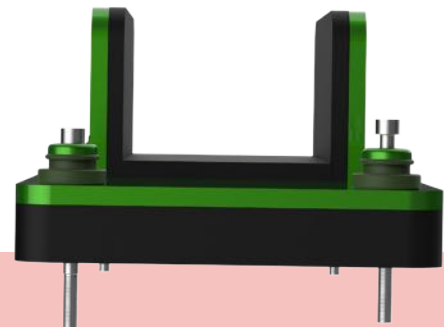

# Preisliste INDUSTRIE

## 2023

\*SENOR Antivibration System



**PFT-1000/ADAPTA**

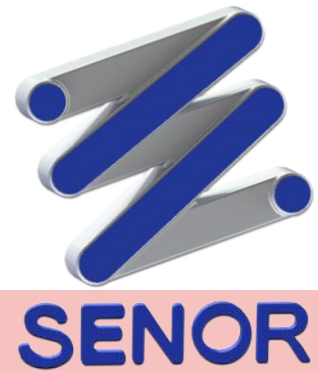



## BODEN - PLATTE / AKUSTIK

Referenz	Belastung mín/máx	UVP €/St
Reference	minimum/maximum load	RRP €/Unit

### WASCHMASCHINEN & SCHLEUDER MASCHINEN

**GESTELL** Entworfen um sicherheit und leistung beizubringen.Hauptzweck ist die beendung von aller mechanischen vibration und schallakustik .

SE-PLM-ADAPTA/LAVADORA 1100 x 1200	Amortiguadores incluidos	6143,20 €
SE-PLM-ADAPTA/LAVADORA 1300 x 1500	Amortiguadores incluidos	6655,14 €
SE-PLM-ADAPTA/LAVADORA 1600 x 1700	Amortiguadores incluidos	7231,06 €



SE-PLM-ADAPTA/WASCHMASCHINE

**Neu**

Hersteller von **ANTIVIBRATIONSSYSTEME**

# Preisliste INDUSTRIE

## 2023

\*SENOR Antivibration System



**\*WÄSCHEREI HOTEL**, Kann Hergestellt werden je Typologie und Bedarfsfall des Kunden.  
( **DESIGN MÖGLICHKEITEN ANFRAGEN** ).

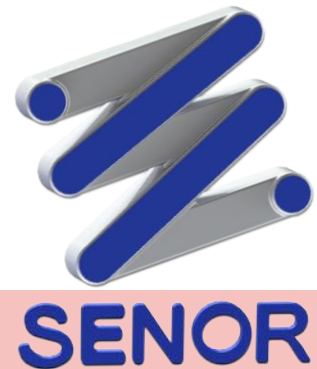



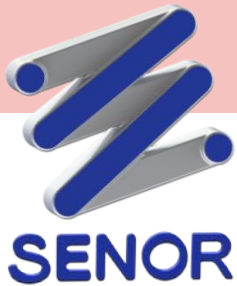

# Preisliste INDUSTRIE 2023

## PLATTE BODEN / **AKUSTISCH**

<b>Referenz</b>	<b>Belastung mínim/máx</b>	<b>UVP €/Stk</b>
Reference	minimum/maximum load	RRP €/Unit

### **AUFZÜGE & ROTIERENDE MASCHINEN**

**GESTELL** Entworfen um jegliche vibro-mechanik zu vermeiden und die schallakustik zu reduzieren

SE-PLM-ADAPTA/AUFZUG 820x300	Federdämpfer inliegend 2201,32 €	<b>Neu</b>
------------------------------	----------------------------------	------------



\*PLM-ADAPTA/AUFZUG  
**Neu**

Hersteller von **ANTIVIBRATIONSSYSTEME**

# Preisliste INDUSTRIE

## 2023

\*SENOR Antivibration System

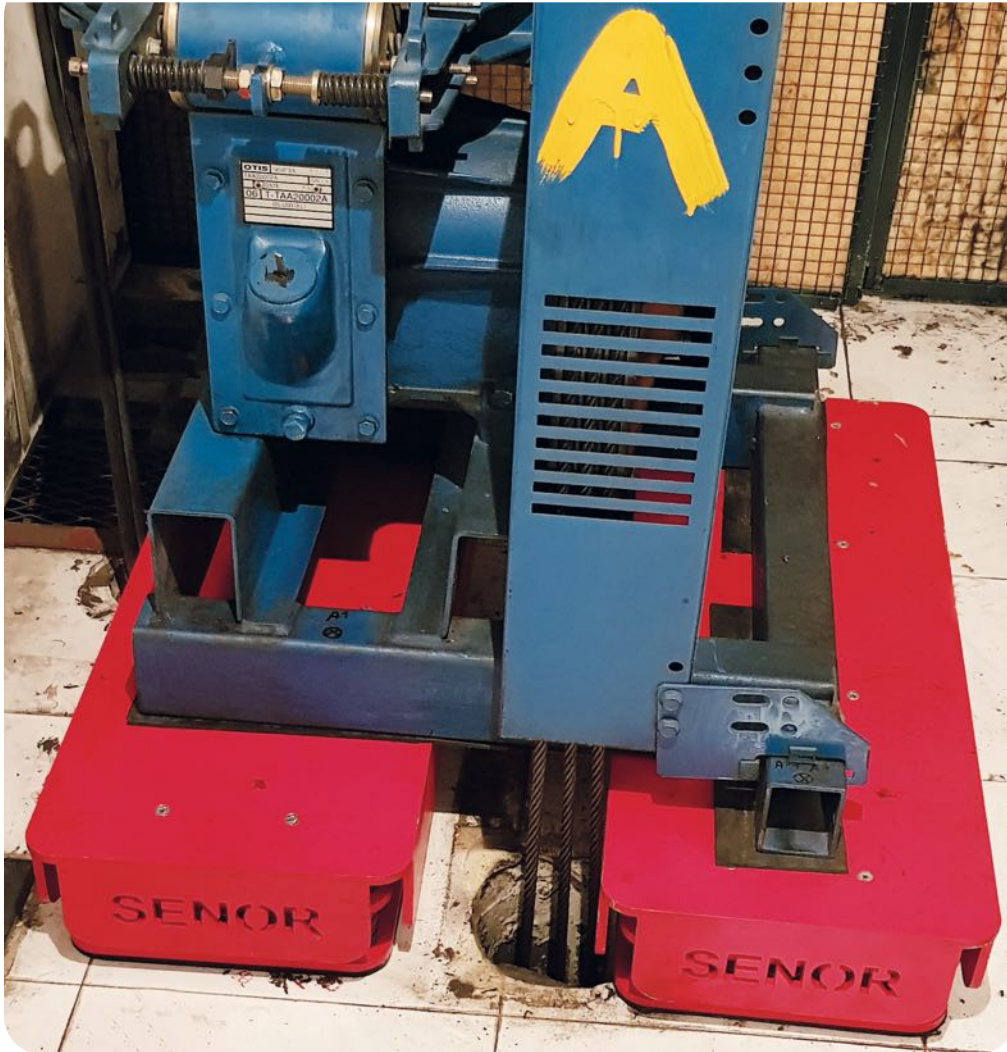

**\*PLM-ADAPTA/AUFZUG**

**Neu**

**\*AUFZUG**, Kann hergestellt und angepasst werden, für jeglichen bedürfnis für den Kunden  
( **BERATUNG ÜBER DESIGNMÖGLICHKEITEN** ).

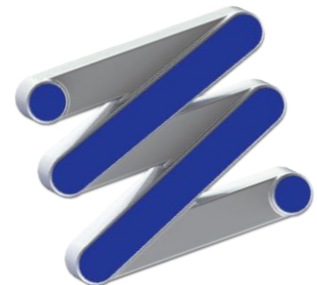

**SENOR**



Eine Welt von **Akustischen Lösungen**

A World of **Acoustic Solutions**

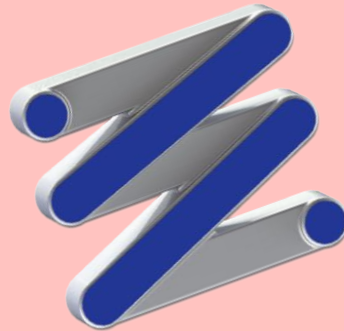

**SENOR**

