

4360/60 V DS

PIVOT DE BORRACHA + AÇO COM FIXAÇÃO DIRETA AO CANAL DE METAL TIPO TC60

O modelo **4360/60 V DS** é um pivot de **BORRACHA + AÇO** para teto com dispositivo de travamento (**DS**), pensado para dar qualidade a qualquer sistema acústico determinado e eliminar as frequências sonoras e vibrações. Este pivot fixa-se no canal com facilidade e rapidez graças ao nosso design exclusivo. Somos os únicos que o podemos fabricar

O modelo **4360/60 V DS** é feito de um polímero de alta qualidade (borracha) que fornece melhorias no campo vibroacústico. Seu principal uso é para pendurar tetos de gesso cartonado acústico com canais de metal, como TC60.

O polímero deste pivot é KRAIBURG-TP, testado de acordo com a norma UNE-EN ISO 10846-1: 2009 (UNE: Associação Espanhola de Estandarização). Atinge uma frequência de ressonância de 7-15 Hz.

*Sistema registrado ante la Oficina Española de Patentes y Marcas.



REFERÊNCIA	COR	MÉTRICA MIN-MAX	CANAL (mm)	CARGA (Kg) MIN-MAX	EMBALLAGEM
SE-4360/60 VDS/24		6 - 8	60	8 - 30	24
SE-4360/60 VDS/80		6 - 8	60	8 - 30	80

USOS

Seu principal uso é a instalação de tetos acústicos

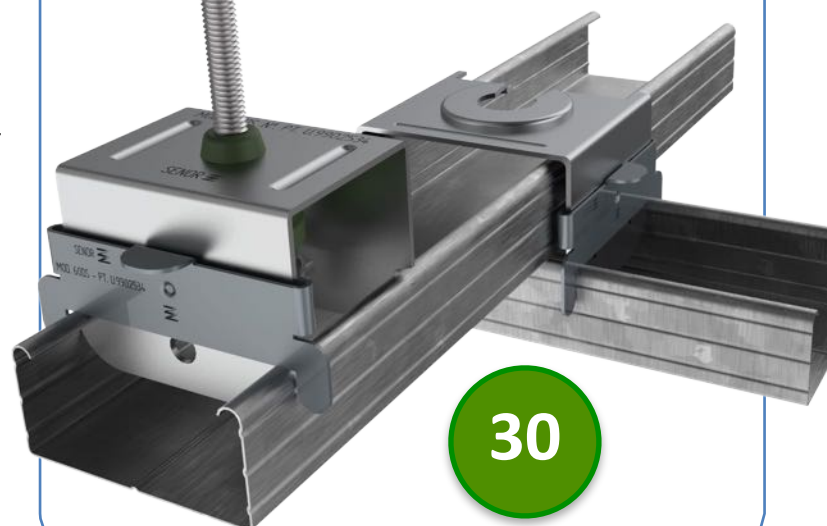

CANAL DE METAL

Canal de teto de aço galvanizado de 60 milímetros.

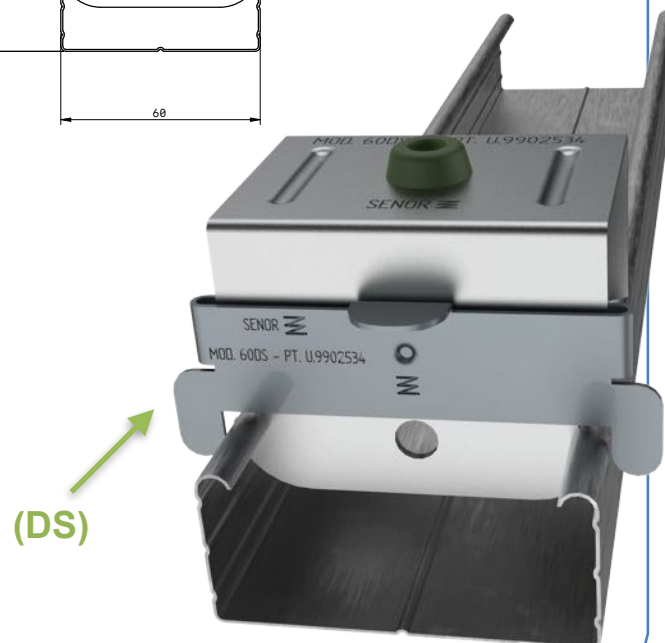
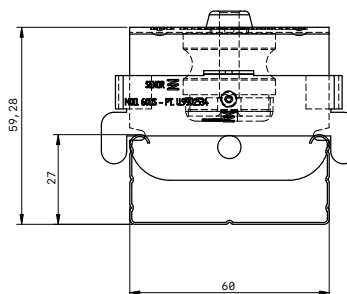



4360/60 V DS

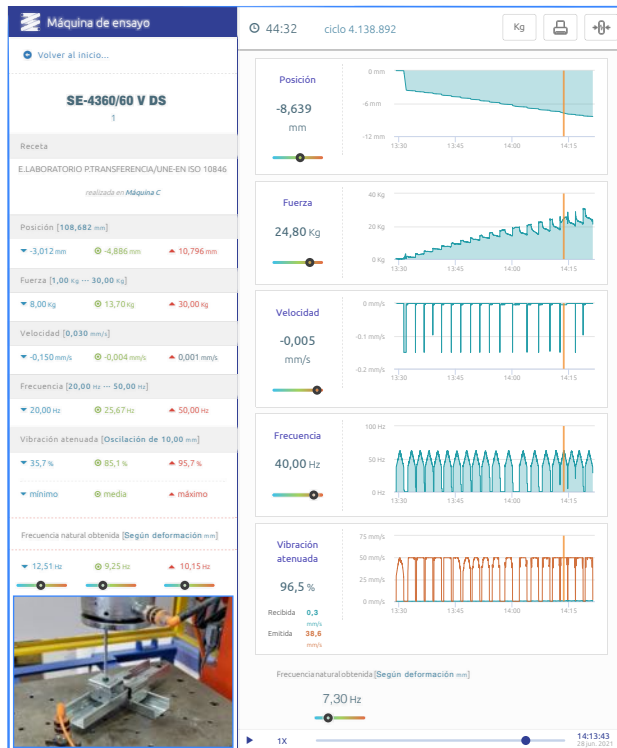

Quadro 1

Ensayo LABORATORIO
UNE-EN ISO 10846-1:2009

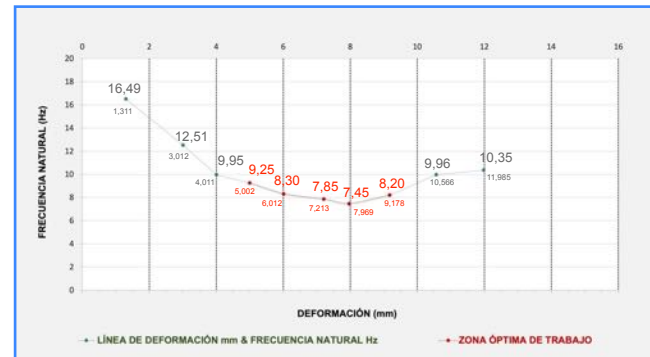
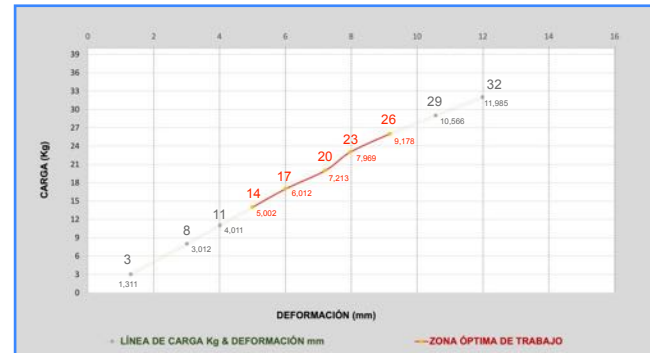

Quadro 2

CARGA (Kg)	DEFORMAÇÃO (mm)	FREQUÊNCIA RESSONÂNCIA (Hz)	VARRIDO (Hz)		GRAU DE ISOLAMENTO (%)	
11	4,011	9,95	25	50	81,18	95,88
14	5,002	9,25	25	50	84,14	96,46
17	6,012	8,30	25	50	87,61	97,17
20	7,213	7,85	25	50	89,06	97,47
23	7,969	7,45	25	50	90,25	97,73
26	9,178	8,20	25	50	87,94	97,24

Quadro 3





*SENOR Aisladores Acústicos

4360/60 V DS

Detalhe 3D Ref.SE-4360/60 V DS

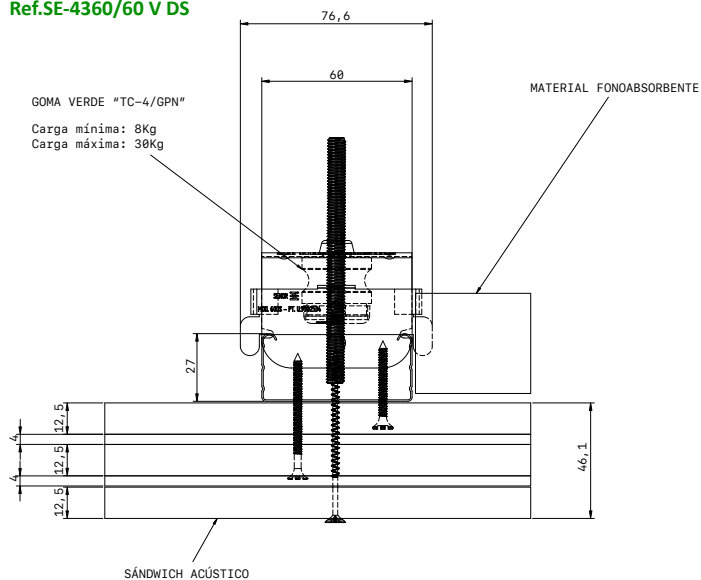

VISTA LATERAL

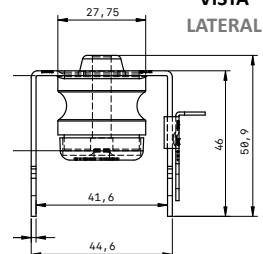

VISTA FRONTAL

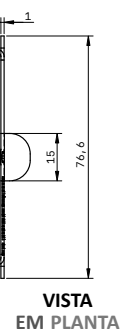
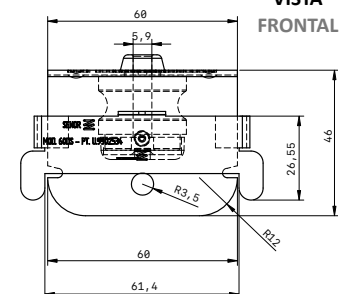

VISTA EM PLANTA

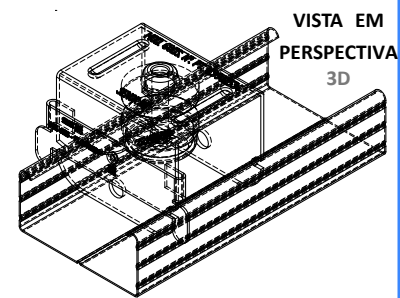

ESCALA 1:1

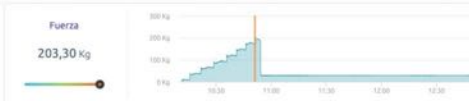
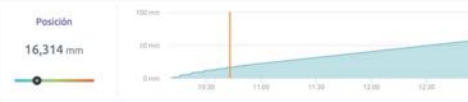
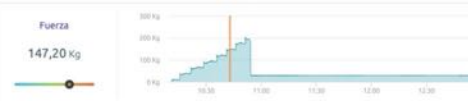
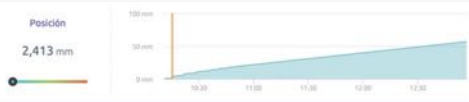

Disposição do ensaio: 24,50 Kg

Disposição do ensaio: 147,20 Kg

Disposição do ensaio: 203,30 Kg

4360/60 V DS



SENOR Aisladores Acústicos

Rastreabilidade / Data do teste:

SENOR 18 / diciembre 2020

Modo de falha

Excedeu o limite acústico do perfil de aço ao atingir **203,30 Kg**. Momento em que a linha de força desce acentuadamente, até chegar aos **27,80 Kg**.

O teste de ruptura está concluído.

Conclusão

Esta forquilha acústica é projetada para suportar cargas entre 8-30 kg (Carga máxima)

Cumpe estritamente com o padrão técnico UNE-EN 13964: 2016 / A1: Teto suspenso. Requisitos e métodos de teste. (UNE: Associação Espanhola para Estandarização).

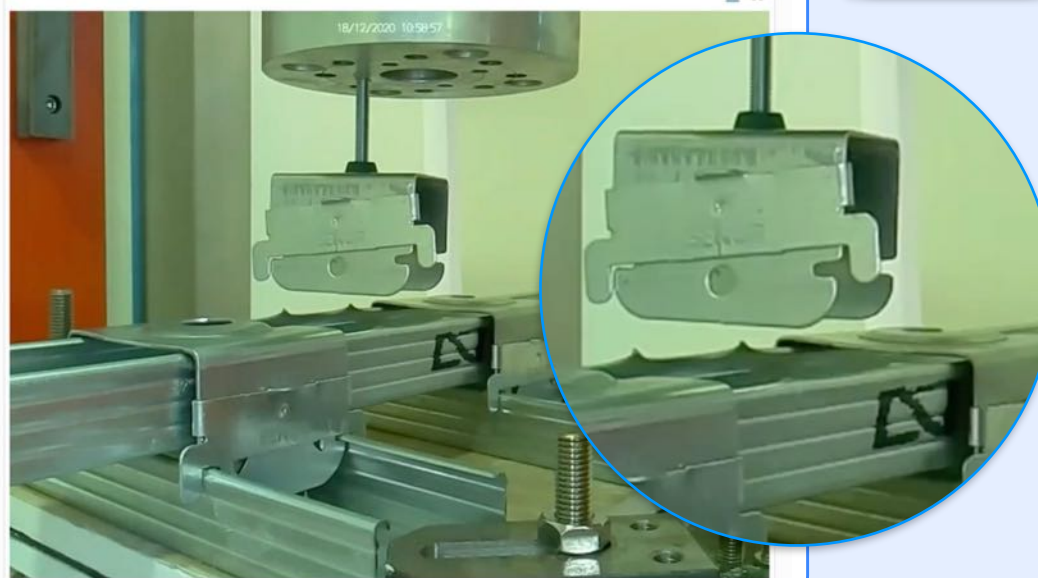
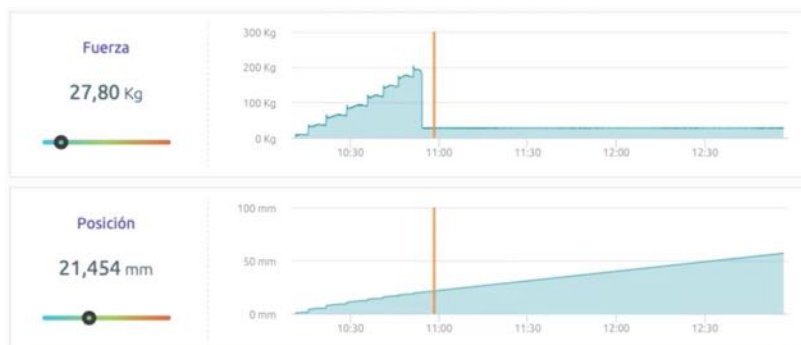

Instalação

