

CONSTRUCTION Catalogue

2021

HYBRID HANGER WITH
DIRECT FASTENING TO **C** PROFILES or **STUD**

Ref. SE-MSN-90 V 45

PATENTED

SEÑOR

CONSTRUCTION Catalogue 2021

HYBRID HANGER WITH DIRECT FASTENING TO C PROFILES or STUD

Ref. SE-MSN-90 V 45



Introduction

A **DIFFERENT** and **PROFESSIONAL** hanger.

Higher performance in the least space.

They are **HYBRID** hangers with locking stops (**ID**) and a perfect installation to profiles **C** or **STUD**.

MSN-90 V 45 is manufactured with high performance and renovated raw material providing improvements in the vibro-acoustic field.

MSN-90 V 45 is more than a hanger.

It is an acoustic hanger with fast adjustment to first profile **C** o **STUD**. The profile is fixed with a simple gesture making him an **innovative** and **unique product**.

We use the latest technology in the production such as: renovated polymers (**KRAIBURG-TPE**) tested according to **UNE-EN ISO 10846-1:2009** and placed in the sides on the steel spiral. The steel spring is manufactured according to **DIN 2095 UNE EN 10270**, with **GREEN EPOXY** treatment.



Manufacturer of **ANTIVIBRATION** systems



*SEÑOR Aisladores Acústicos



CONSTRUCTION Catalogue 2021

HYBRID HANGER WITH **DIRECT** FASTENING TO **C** PROFILES or **STUD**

Ref. SE-MSN-90 V 45



PATENTED

ACOUSTIC / HYBRID Ceiling

STEEL SPRING: it provides a high level of isolation to vibrations in the range of **low/medium** frequencies (Hz).

RENOVATED POLYMERS: they have a better damping factor and a higher degree of isolation to vibration in the range of **medium/high** frequencies (Hz).

COMBINATION: the combination makes possible launch onto the market the best hanger of the moment and reduce the vibrations in the range of **exciter** frequencies.

It is available in several metrics: 6, 8 and 10.

LOAD RANGE (KG)

It is recommended to loads between **15 kg** and **45 kg** of maximum load.
(Strongly recommended not to exceed this limit in order to prevent overstressing the polymer).

RESONANCE frequency: **3-7 Hz**.

CONSTRUCTION Catalogue 2021

HYBRID HANGER WITH DIRECT FASTENING TO C PROFILES or STUD Ref. SE-MSN-90 V 45

LABORATORY Test. UNE-EN ISO 10846-1:2009

Acoustic and vibration. Measurement in the laboratory of vibro-acoustic transfer properties of elastic elements.

Manufacturer of **ANTIVIBRATION** systems

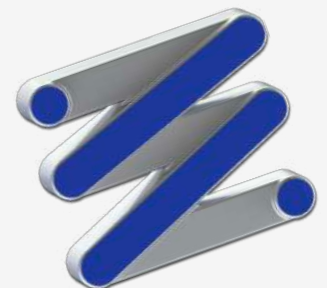
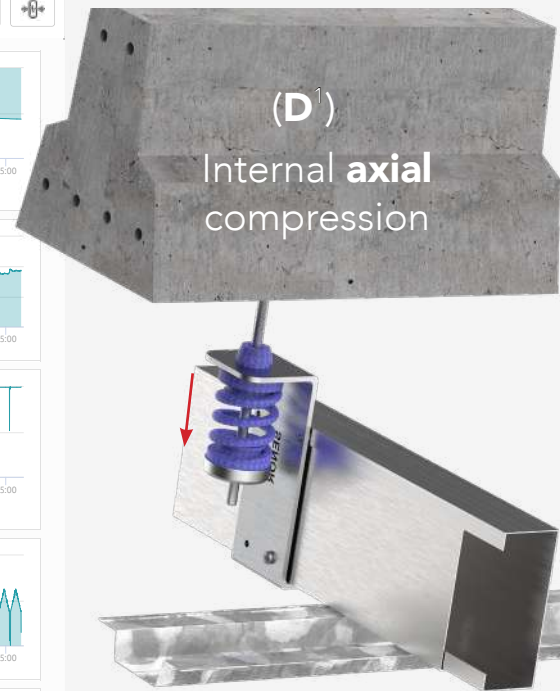
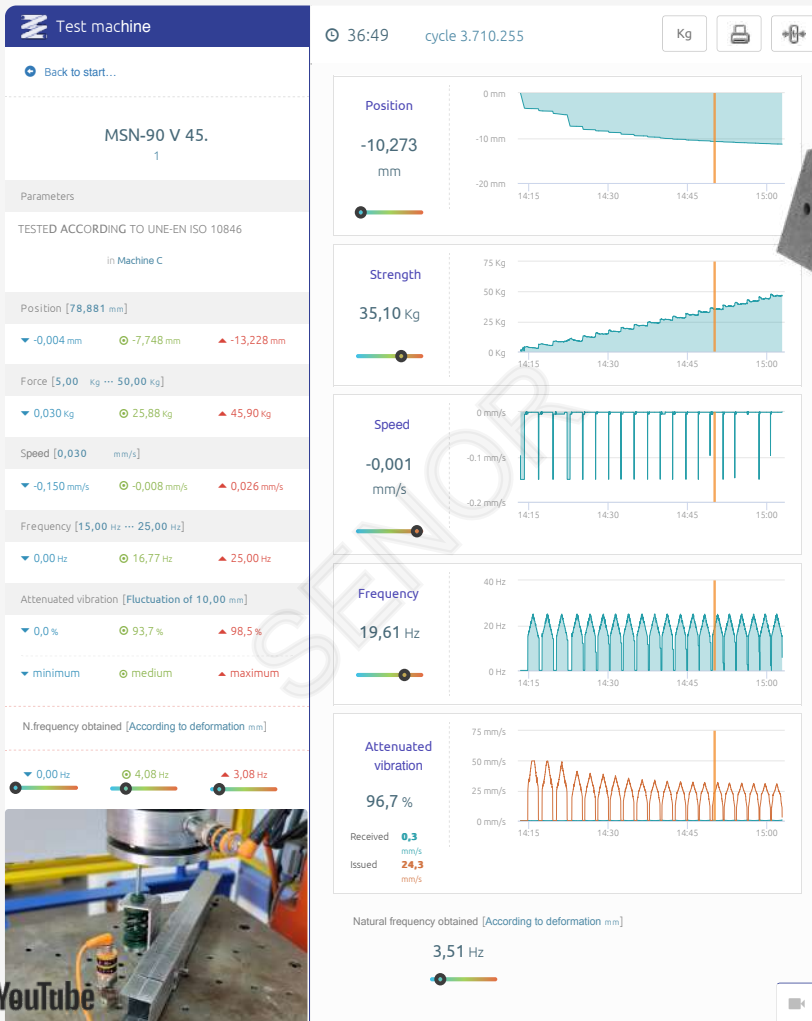

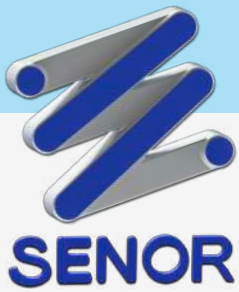

CONSTRUCTION Catalogue 2021

**HYBRID HANGER WITH
DIRECT FASTENING TO C PROFILES or STUD**
Ref. SE-MSN-90 V 45

LABORATORY RESULTS

Chart 1

ACOUSTIC / HYBRID Ceiling

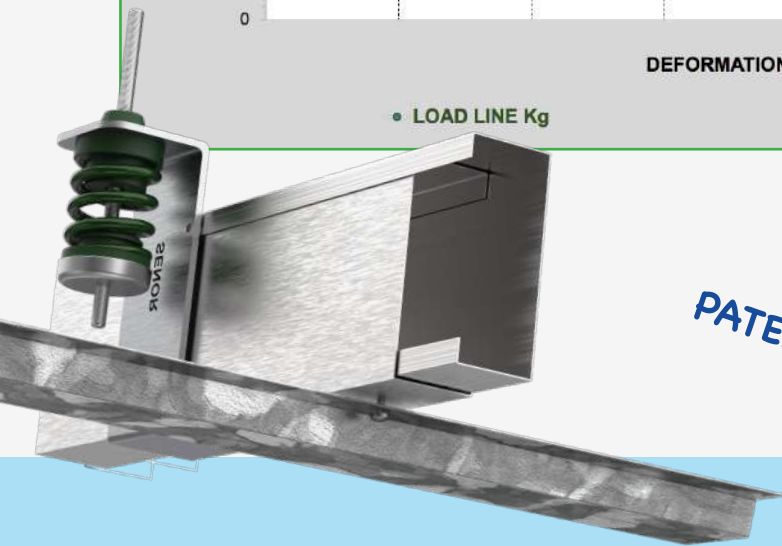

PATENTED

GREEN RUBBER & SPRING:
Available references

- 1° SE-MSN-90 V 45/M6.
- 2° SE-MSN-90 V 45/M8.
- 3° SE-MSN-90 V 45/M10.

CONSTRUCTION Catalogue

2021

HYBRID HANGER WITH DIRECT FASTENING TO C PROFILES or STUD

Ref. SE-MSN-90 V 45

PATENTED

ACOUSTIC / HYBRID Ceiling

Chart 2

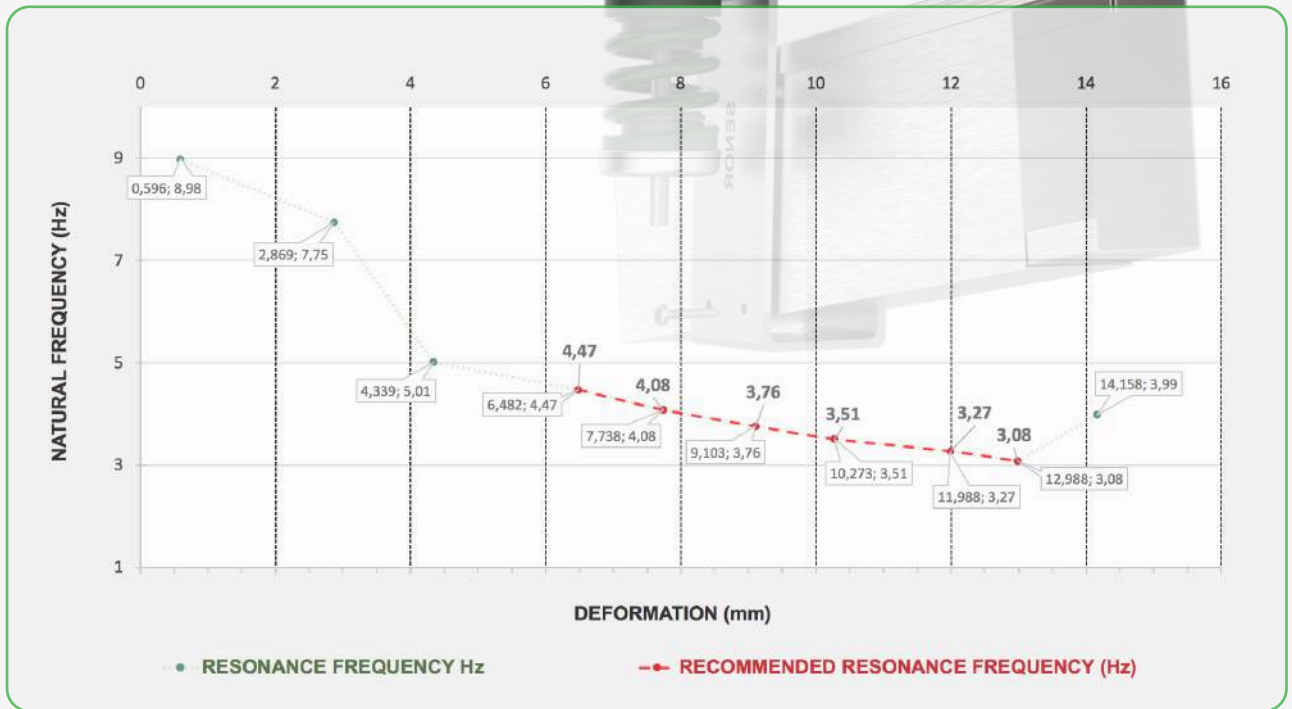

Manufacturer of **ANTIVIBRATION** systems

Ref. SE-MSN-90 V

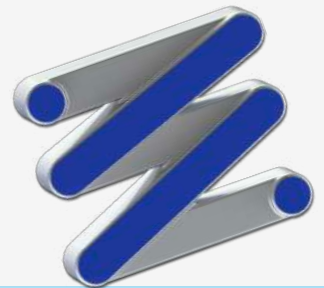

*SENOR Aisladores Acústicos



CONSTRUCTION Catalogue 2021

**HYBRID HANGER WITH
DIRECT FASTENING TO C PROFILES or STUD**
Ref. SE-MSN-90 V 45

LABORATORY RESULTS

Chart 3

ACOUSTIC / HYBRID Ceiling



Ref. SE-MSN-90 V
PATENTED



CONSTRUCTION Catalogue 2021

HYBRID HANGER WITH DIRECT FASTENING TO C PROFILES or STUD

Ref. SE-MSN-90 V 45

DRAWING VIEWS

Manufacturer of **ANTIVIBRATION** systems

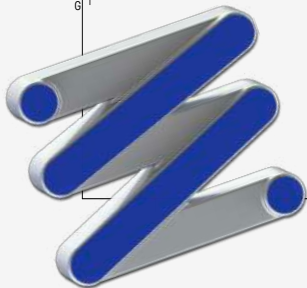
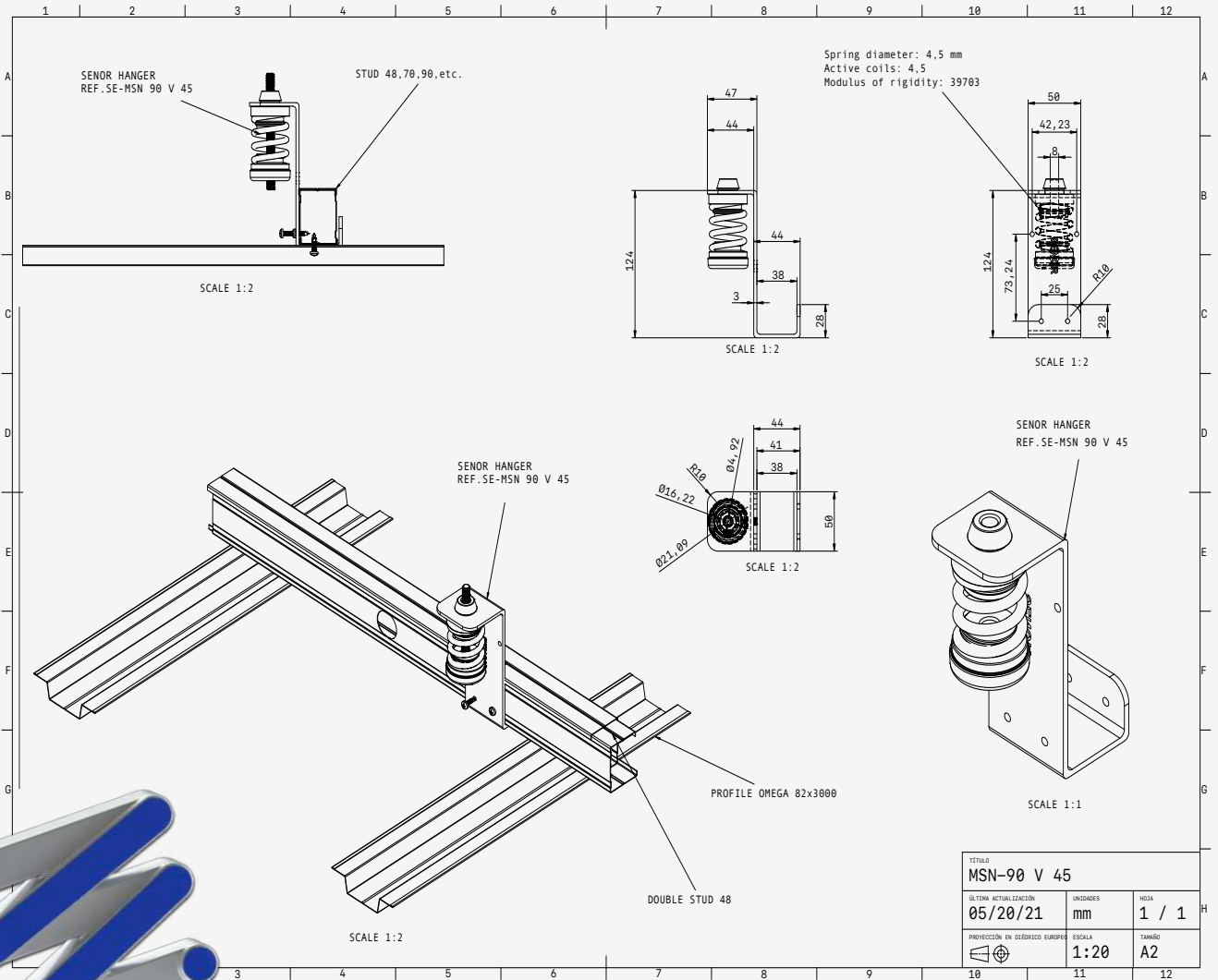

*SENOR Aisladores Acústicos

SENOR



CONSTRUCTION Catalogue 2021

**HYBRID HANGER WITH
DIRECT FASTENING TO C PROFILES or STUD**
Ref. SE-MSN-90 V 45

Mechanical test LABORATORY

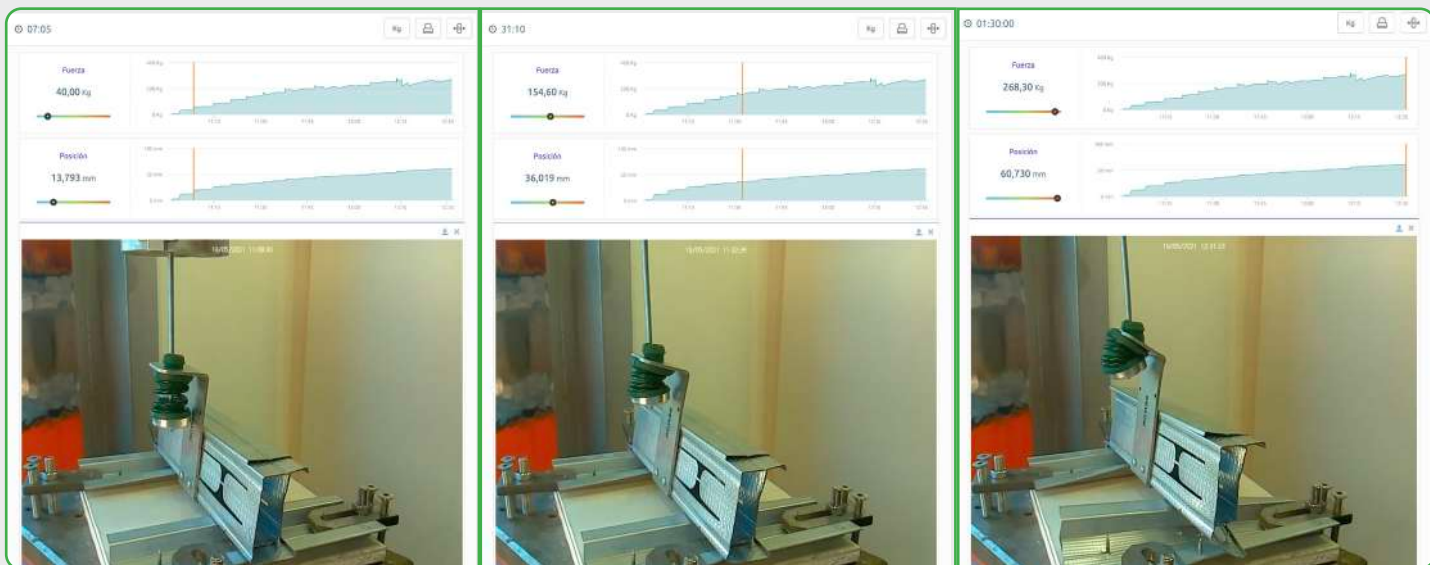

Test layout: 40 kg

MSN-90 V 45

In this test, the hanger is subjected to load inside the parameters designed to the product.

Ref. SE-MSN-90 V

PATENTED

Test layout: 154,6 kg

MSN-90 V 45

In this test, the hanger is subjected to load out of the parameters designed to the product.

We can see steel spring and polymers very compressed.

Test layout: 268,3 kg

MSN-90 V 45

Failure mode.
The components are deformed and the profiles are twisted reaching its elastic limit.

CONSTRUCTION Catalogue 2021

HYBRID HANGER WITH DIRECT FASTENING TO C PROFILES or STUD

Ref. SE-MSN-90 V 45

Manufacturer of **ANTIVIBRATION** systems

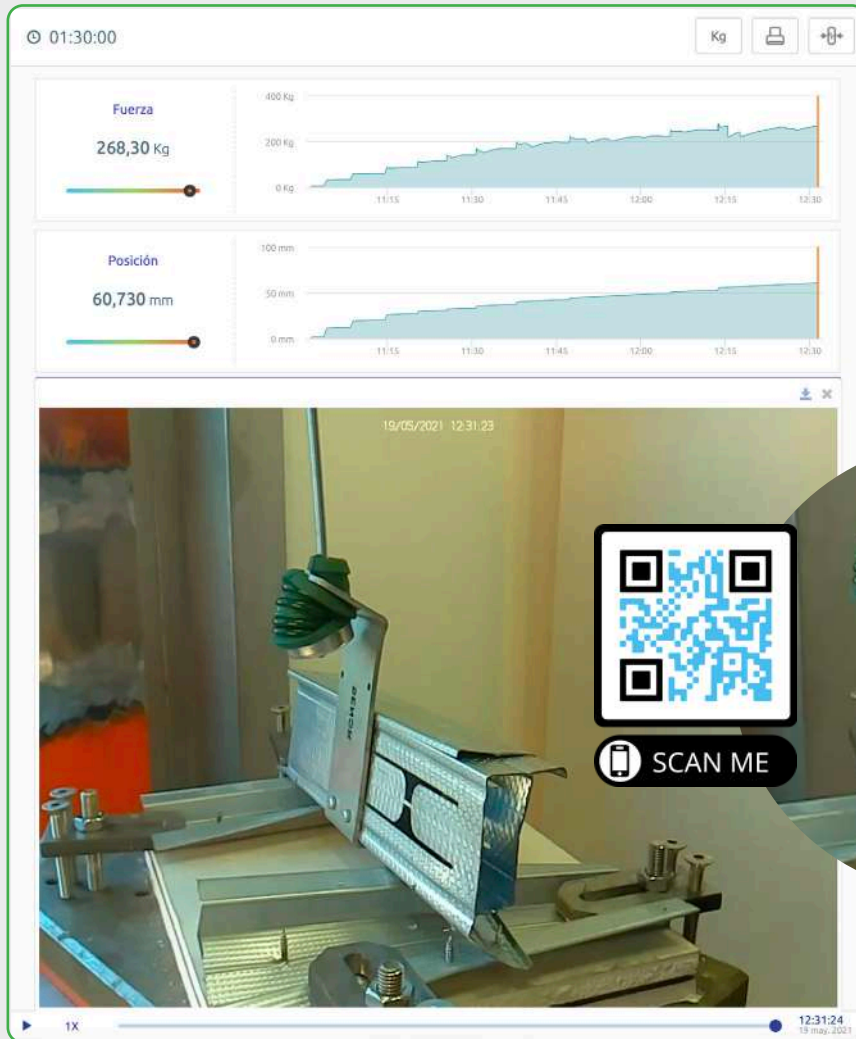

MSN-90 V 45

Failure mode.

The elastic limit of the component is reached at **268 kg**.

The burst test is concluded.

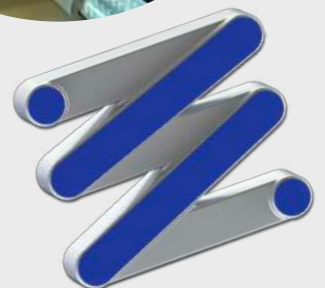

*SENOR Aisladores Acústicos

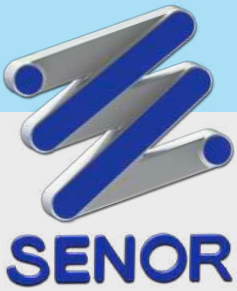

CONSTRUCTION Catalogue 2021

**HYBRID HANGER WITH
DIRECT FASTENING TO C PROFILES or STUD**
Ref. SE-MSN-90 V 45

Certificate of Compliance



SENR certifies:

The **MSN-90 model** in the construction range for the suspension of low acoustic false ceilings under slab has an **optimal lifespan of 10 years** provided that the installation is carried out under **ordinary environmental conditions** and are not exposed to chemical components that could degrade the product. The MSN-90 model strictly complies with **UNE** (Spanish Association for Standardization) **UNE 100-153-88**: air conditioning: vibration insulators: design criteria.

SENR declares under its responsibility that the following components for suspended ceiling in buildings strictly complies with the technical sections of installation mentioned in the technical documentation of the product.

Certificación
Concedida a
SUSPENSIONES ELASTICAS DEL NORTE SL

PLG. IND. EL GARROTAL, PARCELA 10 MODULO 5 - 14700 - PALMA DEL RIO - CÓRDOBA. - ESPAÑA

Bureau Veritas Certification certifica que el Sistema de Gestión ha sido auditado y encontrado conforme con los requisitos de la norma:

NORMA
ISO 9001:2015

El Sistema de Gestión se aplica a:

DISEÑO, DESARROLLO Y FABRICACIÓN DE AISLADORES ACÚSTICOS PARA LA ERRADICACIÓN DE LAS VIBRACIONES Y LA CONTAMINACIÓN POR RUIDO PARA SU APLICACIÓN EN LOS SECTORES DE LA CONSTRUCCIÓN Y LA INDUSTRIA.

Número del Certificado:	ES114742- 1
Aprobación original:	25-09-2002
Auditoría de certificación/renovación:	14-09-2020
Caducidad de ciclo anterior:	03-10-2020
Certificado en vigor:	04-10-2020
Caducidad del certificado:	03-10-2023

Este certificado está sujeto a los términos y condiciones generales y particulares de los servicios de certificación

Bureau Veritas Iberia S.L.
C/ Valportillo Primera 22-24, Edificio Caoba, 28108 Alcobendas - Madrid, España

CONSTRUCTION Catalogue 2021

HYBRID HANGER WITH DIRECT FASTENING TO C PROFILES or STUD

Ref. SE-MSN-90 V 45

Manufacturer of **ANTIVIBRATION** systems

Warning

Relevant information

SEÑOR reserves the right to make changes in specifications at any time without prior notice. It is a responsibility of the user to use the latest and updated version of the product data sheets. A copy of which will be available on request. This information and, in particular, relative recommendations to the application and final use of the product, are given in good faith, based on **SEÑOR** knowledge and experience of its products, provided that they are correctly installed in ordinary circumstances and within its useful life.

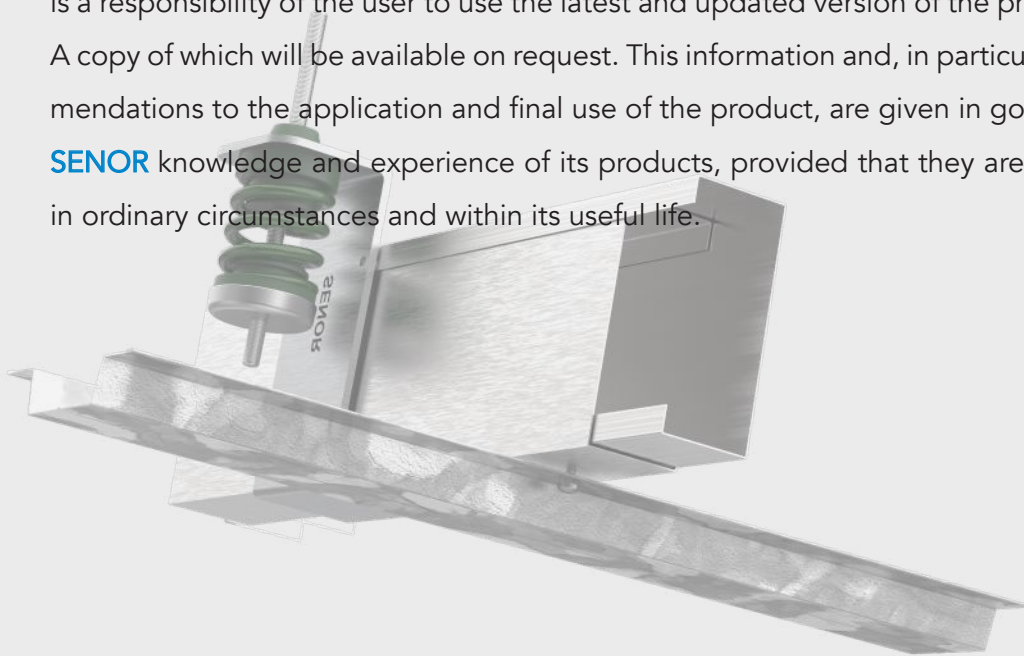

Ref. SE-MSN-90 V

PATENTED

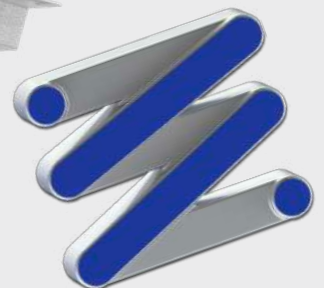

*SEÑOR Aisladores Acústicos