

4360/60 V DS MODEL

RUBBER + STEEL ACOUSTIC HANGER WITH DIRECT FASTENING TO METAL CHANNEL TC60

The **4360/60 V DS** model is a **RUBBER + STEEL** hanger with locking device (**DS**) devised to provide quality to any given acoustic system and to eradicate sound frequencies and vibrations. This hanger get fastened into the channel easily and quickly thanks to our exclusive design. *We are the only ones who can manufacture it.*

The **4360/60 V DS** model is made of a high quality polymer (rubber) which provides improvements in the **vibro-acoustic** field.

The polymer of this hanger is **KRAIBURG-TPE** tested according to standard **UNE-EN ISO 10846-1:2009** (UNE: Spanish Association for Standardization). It reaches a resonance frequency of **7-15 Hz**.

**This product has been registered in the Spanish Patents and Trademarks Office.*



USES

Its main use is the installation of acoustic ceilings using galvanized steel channel such as TC60

METAL CHANNEL

Galvanized steel ceiling channel
60 millimeters

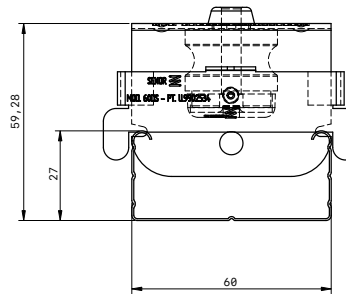

REF.	COLOUR	METRIC MIN-MAX	CHANNEL (mm)	LOAD (Kg) MIN-MAX	PACKING
SE-4360/60 VDS/24		6 - 8	60	8 - 30	24
SE-4360/60 VDS/80		6 - 8	60	8 - 30	80

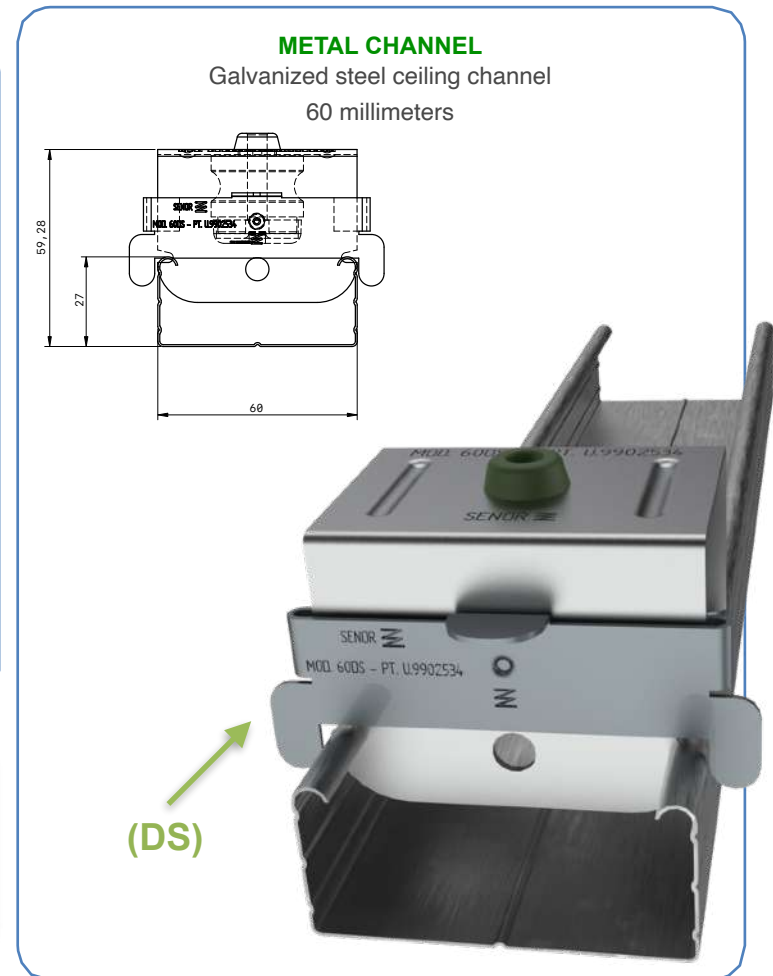



4360/60 V DS MODEL

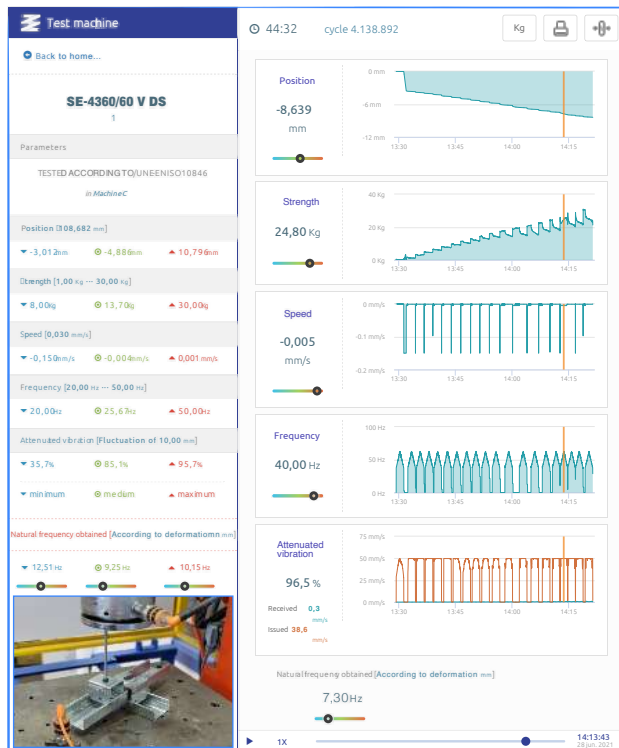
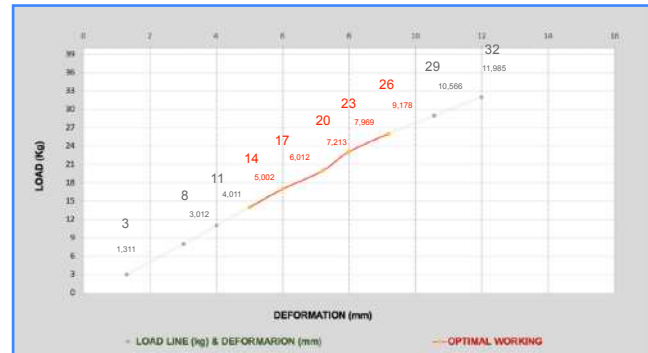

Chart 1



Laboratory test
UNE-EN ISO 10846-1:2009

Chart 2

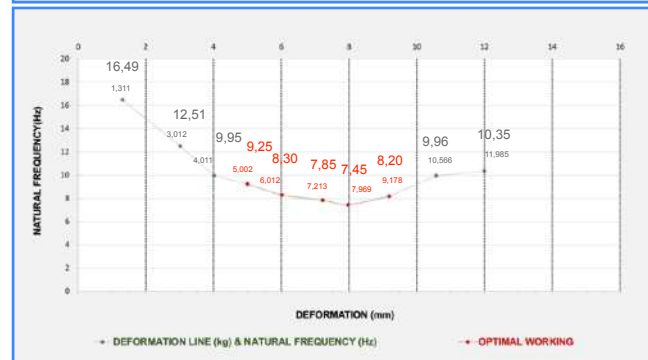
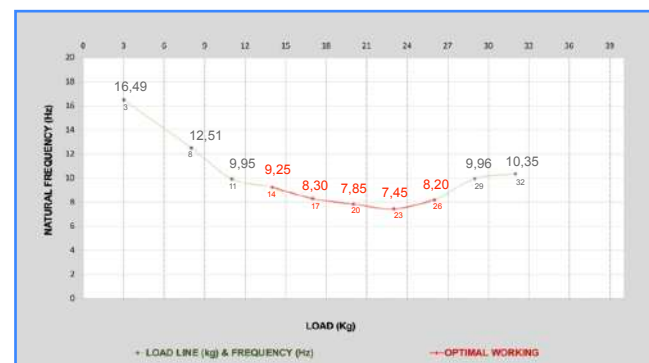

Chart 3



LOAD (Kg)	DEFORMATION (mm)	RESONANCE FREQUENCY (Hz)	SWEEP (Hz)		SOUNDPROOFING LEVEL (%)	
11	4,011	9,95	25	50	81,18	95,88
14	5,002	9,25	25	50	84,14	96,46
17	6,012	8,30	25	50	87,61	97,17
20	7,213	7,85	25	50	89,06	97,47
23	7,969	7,45	25	50	90,25	97,73
26	9,178	8,20	25	50	87,94	97,24



*SEÑOR Aisladores Acústicos

4360/60 V DS MODEL

3D DETAIL

Ref.SE-4360/60 V DS

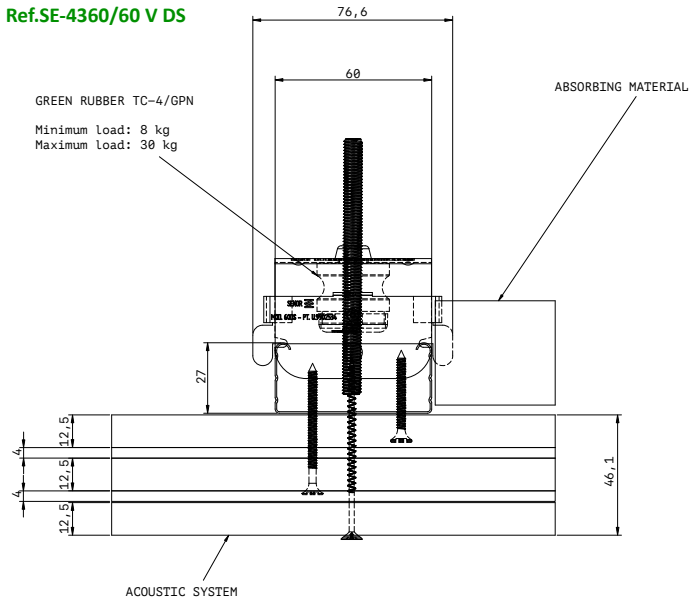

SIDE VIEW

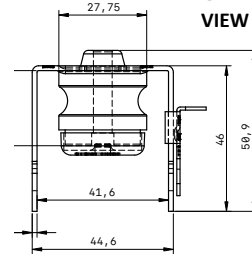

FRONT VIEW

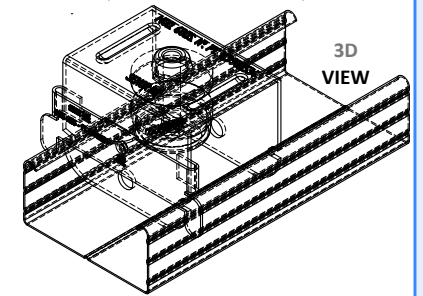
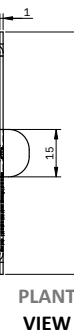
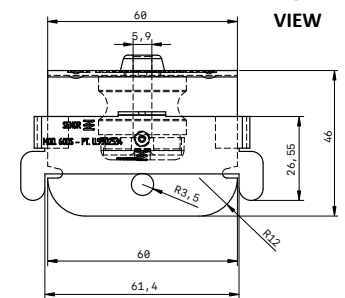

SCALE 1:1

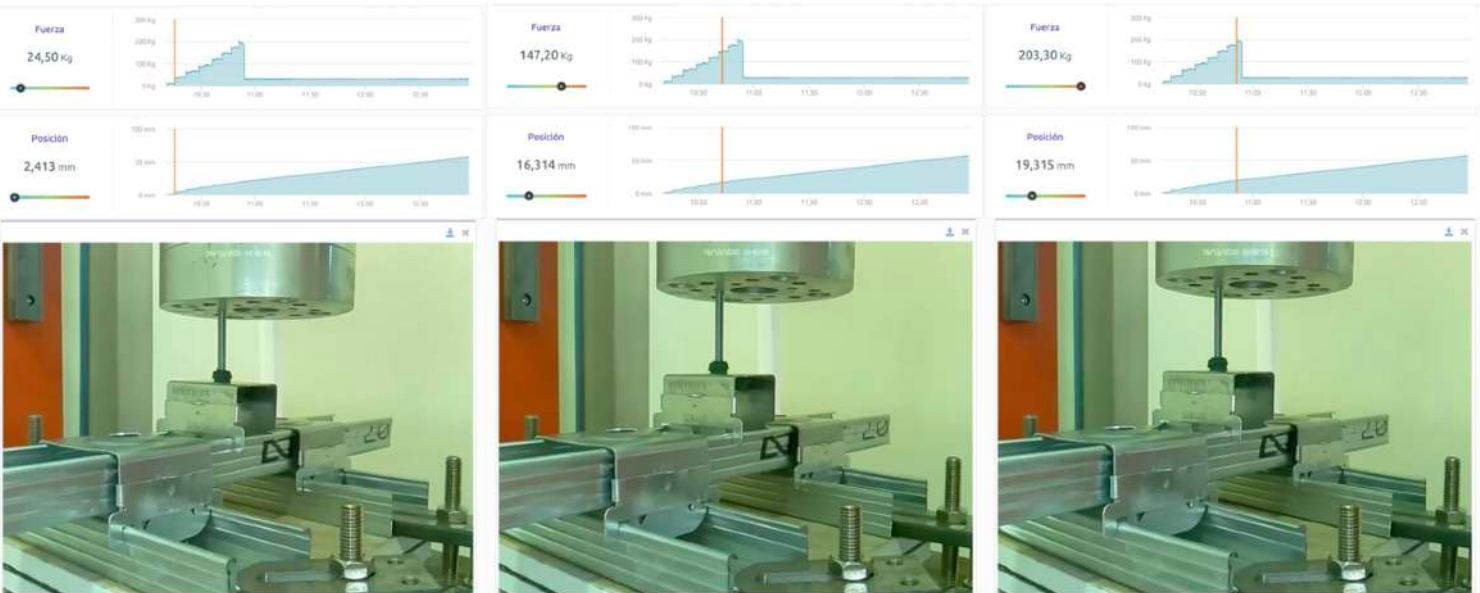

Applied load: 24,50 Kg

Applied load: 147,20 Kg

Applied load: 203,30 Kg

4360/60 V DS MODEL



SENOR Aisladores Acústicos

Test date

SENOR 18th December 2020

Failure mode

This acoustic hanger exceeds the elastic limit of ceiling channel by reaching **203,30 Kg**. In this case, the strength line goes down and reaches **27,80 Kg**.

The burst test is concluded.

Conclusion

This acoustic hanger is designed to bear loads between **8-30 kg** (maximum load).

It strictly complies with standard **UNE-EN 13964:2016/A1**. Suspended ceiling. Requirements and test methods. (UNE: Spanish Association for Standardization).

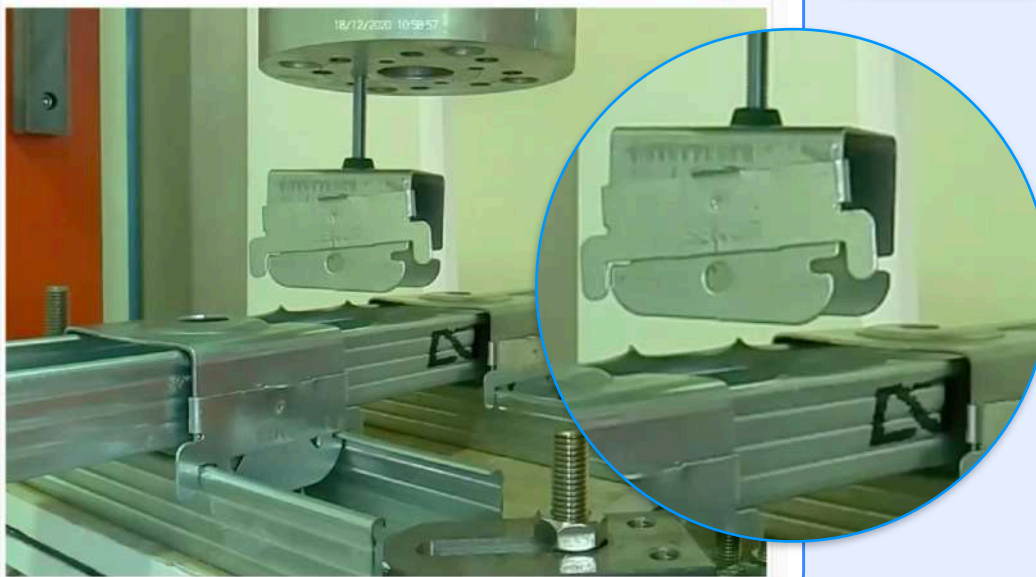
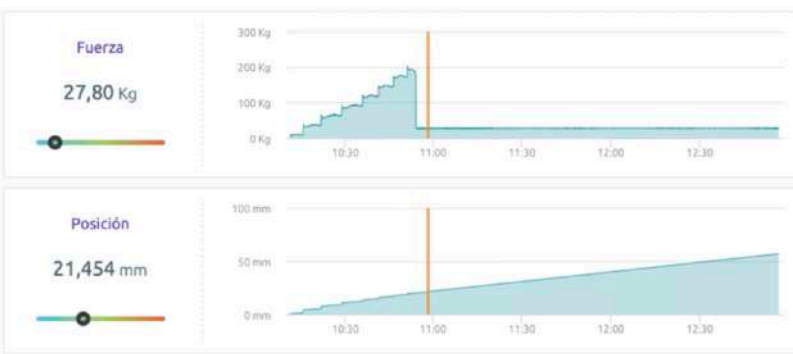

INSTALLATION

